

BD SYSTEM



BD SYSTEM

La nuova linea BD SYSTEM si basa su un profilo principale progettato per poter realizzare box doccia sia con ante battenti a bilico (**BD-B**) sia con porte apribili a soffietto (**BD-S**). La dimensione ridotta del profilo, di soli 23x31 mm, dona una linea elegante e minimale al sistema.

All'interno sono installati gli appositi attacchi a scomparsa per un corretto funzionamento ed un fissaggio ottimale.

I sistemi sono stati ideati abbinando alcuni accessori già presenti sul nostro catalogo ed altri realizzati appositamente per soddisfare le esigenze più particolari.

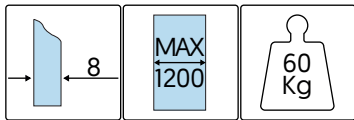
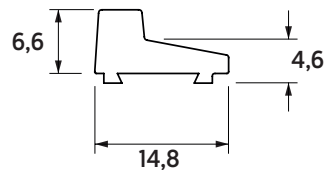
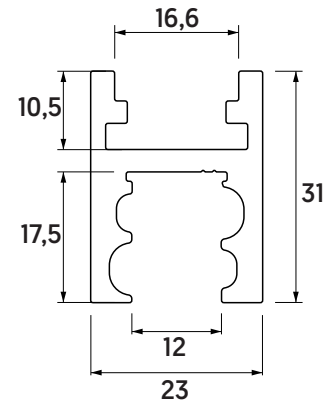

In entrambe le tipologie di montaggio è prevista l'applicazione di una sottile diga ribassata lungo tutto il perimetro del piatto doccia, creando una barriera che evita la fuoriuscita dell'acqua con il minimo impatto visivo. La diga non necessita della foratura del piatto doccia ma può essere installata direttamente con silicone o in alternativa con biadesivo resistente all'acqua.

I due sistemi sono forniti in KIT con profili di lunghezza 1500 o 2000 mm e componenti standard per la realizzazione completa. Le guarnizioni e le maniglie sono escluse.

È possibile richiedere anche la creazione di KIT per realizzazioni particolari con angoli variabili e aperture personalizzate.





BD-B SYSTEM

BD-B è un sistema che offre la possibilità di realizzare ante battenti di larghezza elevata grazie all'utilizzo di cerniere a bilico in posizione decentrata rispetto al bordo della porta.

La basetta della cerniera superiore è studiata appositamente per alloggiare nella guida mentre quella della cerniera inferiore è sagomata per garantire continuità alla diga ribassata a pavimento.

Questi attacchi consentono di fissare l'asse della porta in qualsiasi posizione.

È inoltre possibile inserire dei vetri fissi in linea con l'anta battente grazie a dei morsetti realizzati appositamente per il fissaggio alla diga ribassata.

I kit vengono forniti con profili da 1500 mm o 2000 mm e sono completi di attacchi e accessori per il montaggio. Grazie alla grande versatilità è possibile creare dei kit su misura con più ante o con angoli intermedi.

Maniglie e guarnizioni sono escluse.

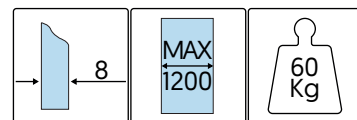

FISSAGGIO MURO/MURO



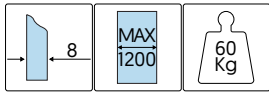
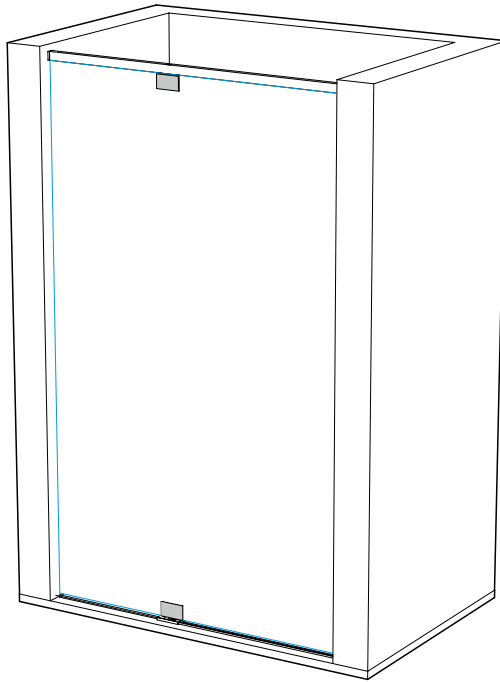

Terminale regolabile per il fissaggio a muro
 Cerniere a scatto con rotazione a 360°
 Blocco dell'anta a +90°, -90°, 180°

Guarnizioni e maniglia escluse

Materiale: profili in alluminio
 cerniere in ottone

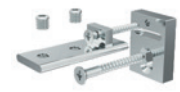
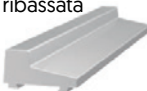

Codice	Finitura
80128501	Cromo lucido
80128521	Nero opaco

COMPONENTI INCLUSI NEL KIT	
Profilo superiore  L= 1500 mm	Profilo tampone  L= 1500 mm
Attacco a muro  x2 pz	Diga ribassata  L= 1500 mm
Cerniera superiore  x1 pz	Cerniera inferiore  x1 pz

DIMENSIONAMENTO FISSAGGIO MURO/MURO

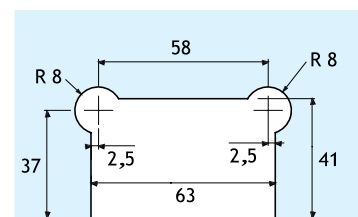
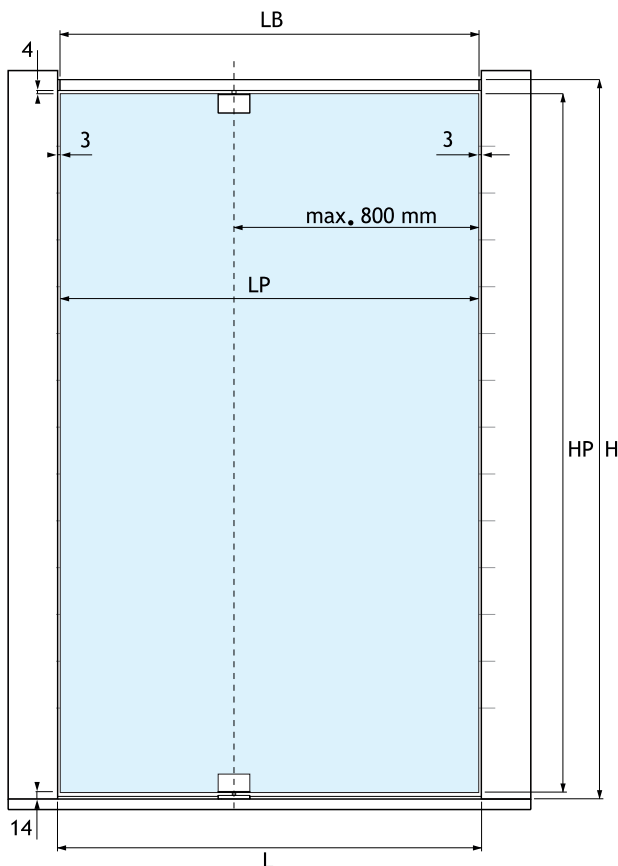

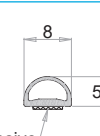
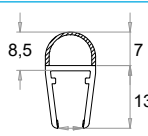
DIMENSIONAMENTO ORIZZONTALE		
SENZA GUARNIZIONI	GUARNIZIONE a PALLONCINO ADESIVO [cod. 80124045]	GUARNIZIONE a PALLONCINO ad INCASTRO [cod. 80124001]
	 Biadesivo	
LP= L-6 mm	LP= L-8 mm	LP= L-18 mm
HP= H-49 mm	HP= H-49 mm	HP= H-49 mm
LB= L-15 mm	LB= L-15 mm	LB= L-15 mm

FISSAGGIO MURO/MURO CON FISSO FRONTALE

Terminale regolabile per il fissaggio a muro

Cerniere a scatto con rotazione a 360°

Blocco dell'anta a +90°, -90°, 180°

Guarnizioni e maniglia escluse

Materiale: profili in alluminio
cerniere in ottone

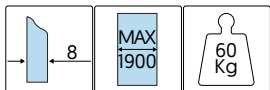
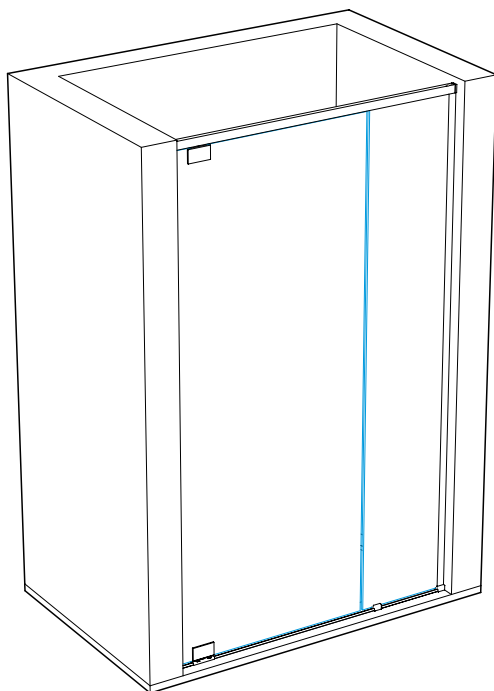
**Codice**

80128503

80128523

Finitura

Cromo lucido

Nero opaco

COMPONENTI INCLUSI NEL KIT

Profilo superiore  L= 2000 mm	Profilo tampone  L= 2000 mm
Attacco a muro  x2 pz	Diga ribassata  L= 2000 mm
Cerniera superiore  x1 pz	Cerniera inferiore  x1 pz
Profilo verticale  L= 2200 mm	Morsetto per vetro fisso  x2 pz
Guarnizione per anta fissa  L= 1000 mm	

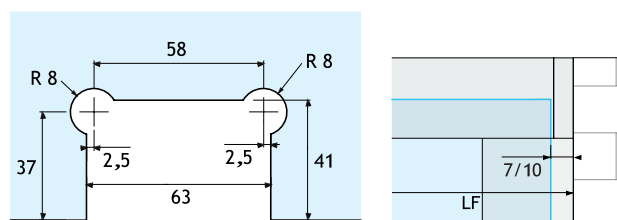
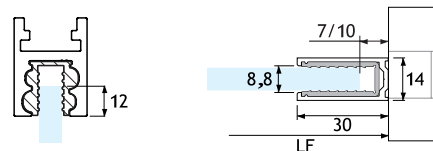
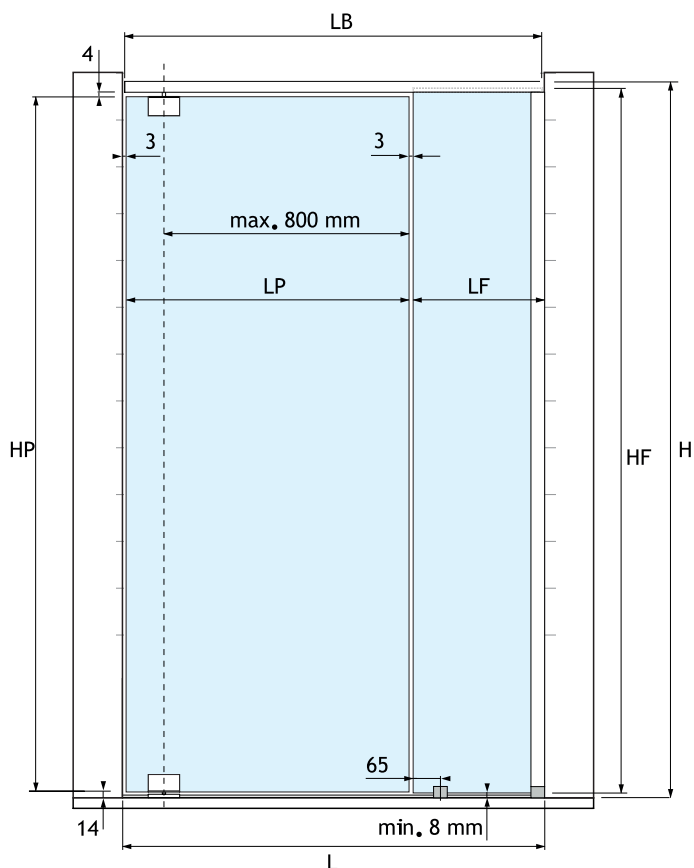
DIMENSIONAMENTO FISSAGGIO MURO/MURO CON FISSO FRONTALE**DIMENSIONAMENTO ORIZZONTALE**

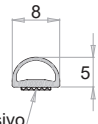
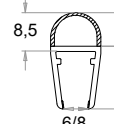
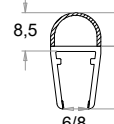
SENZA GUARNIZIONI	GUARNIZIONE a PALLONCINO ADESIVO (cod. 80124045)	GUARNIZIONE a PALLONCINO ad INCASTRO (cod. 80124001)
		
LP= L-6 mm	LP= L-8 mm	LP= L-18 mm
HP= H-49 mm	HP= H-49 mm	HP= H-49 mm
LB= L-15 mm	LB= L-15 mm	LB= L-15 mm
HF= H-27	HF= H-27	HF= H-27

FISSAGGIO VETRO/MURO

Terminale regolabile per il fissaggio a muro e vetro

Cerniere a scatto con rotazione a 360°

Blocco dell'anta a +90°, -90°, 180°

Guarnizioni e maniglia escluse

Materiale: profili in alluminio
cerniere in ottone

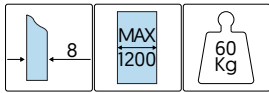
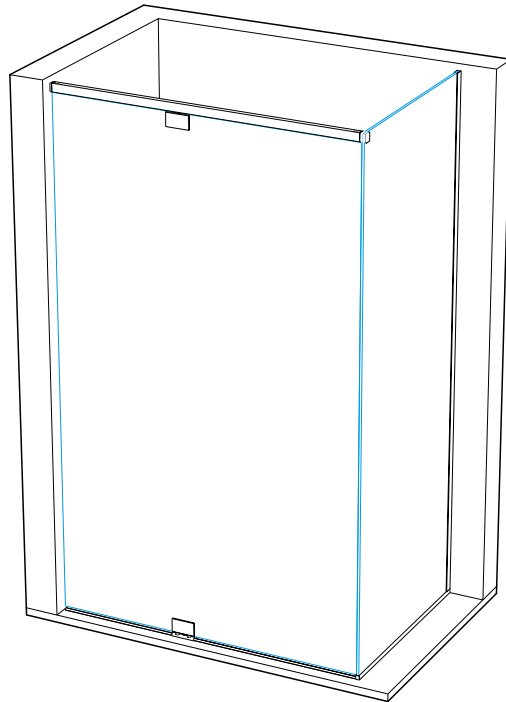

Codice

Finitura

80128505

Cromo lucido

80128525

Nero opaco

COMPONENTI INCLUSI NEL KIT

<p>Profilo superiore L= 1500 mm</p>	<p>Profilo tampone L= 1500 mm</p>
<p>Attacco a muro x2 pz</p>	<p>Diga ribassata L= 1500 mm</p>
<p>Cerniera superiore x1 pz</p>	<p>Cerniera inferiore x1 pz</p>
<p>Profilo verticale L= 2200 mm</p>	<p>Profilo ad U per spalla con tappo L=1000 mm</p>
<p>Terminale per spalla in vetro x1 pz</p>	

DIMENSIONAMENTO FISSAGGIO VETRO/MURO

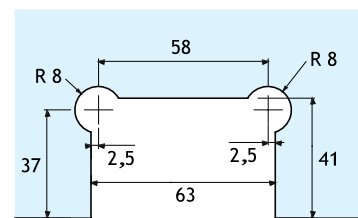
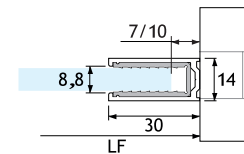
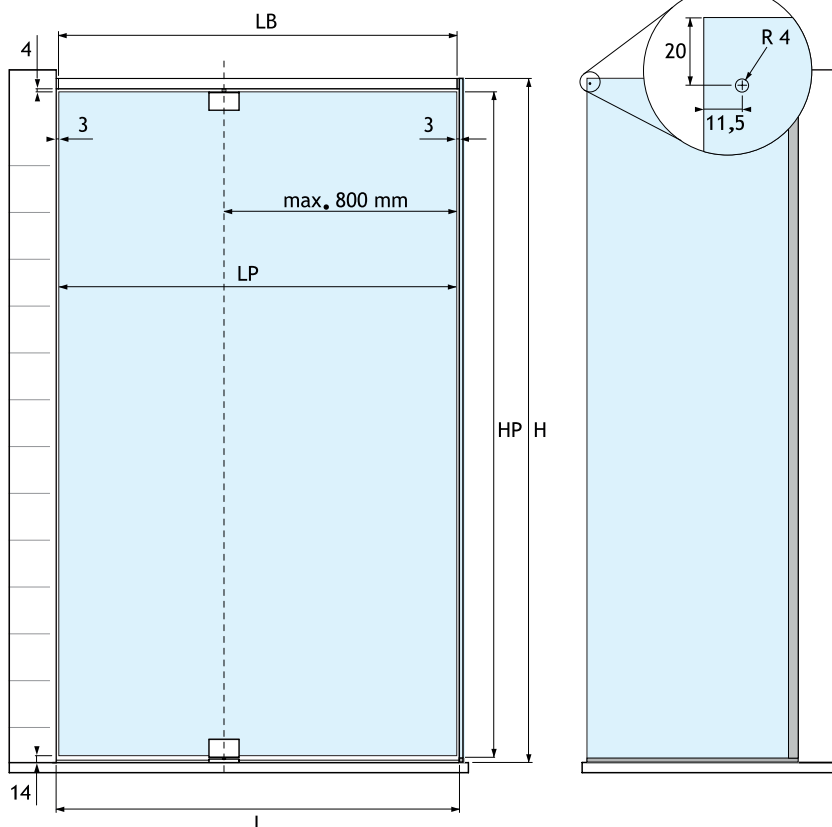

DIMENSIONAMENTO ORIZZONTALE

SENZA GUARNIZIONI	GUARNIZIONE a PALLONCINO ADESIVO [cod. 80124045]	GUARNIZIONE a PALLONCINO ad INCASTRO [cod. 80124001]
LP= L-6 mm	LP= L-8 mm	LP= L-18 mm
HP= H-49 mm	HP= H-49 mm	HP= H-49 mm
LB= L-15 mm	LB= L-15 mm	LB= L-15 mm

FISSAGGIO VETRO/MURO CON FISSO FRONTALE

Terminale regolabile per il fissaggio a muro e vetro

Cerniere a scatto con rotazione a 360°

Blocco dell'anta a +90°, -90°, 180°

Guarnizioni e maniglia escluse

Materiale: profili in alluminio
cerniere in ottone

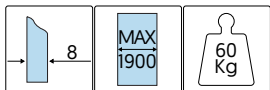
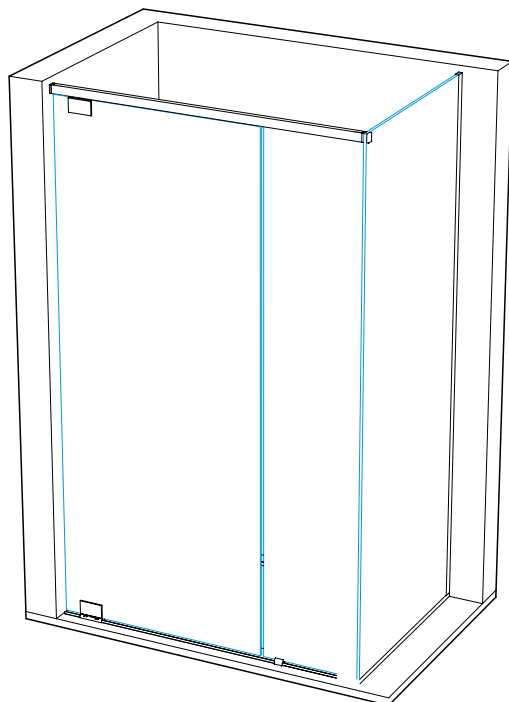
**Codice**

80128507

80128527

Finitura

Cromo lucido

Nero opaco

COMPONENTI INCLUSI NEL KIT

Profilo superiore  L= 2000 mm	Profilo tampone  L= 2000 mm
Attacco a muro  x2 pz	Diga ribassata  L= 2000 mm
Cerniera superiore  x1 pz	Cerniera inferiore  x1 pz
Profilo verticale  L= 2200 mm	Profilo ad U per spalla con tappo  L=1000 mm
Terminale per spalla in vetro  x1 pz	Morsetto per vetro fisso  x2 pz
Guarnizione per anta fissa  L= 1000 mm	

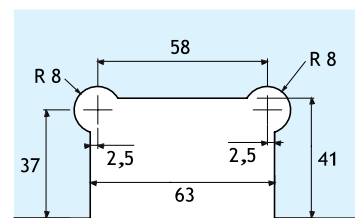
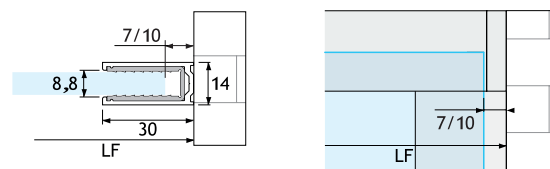
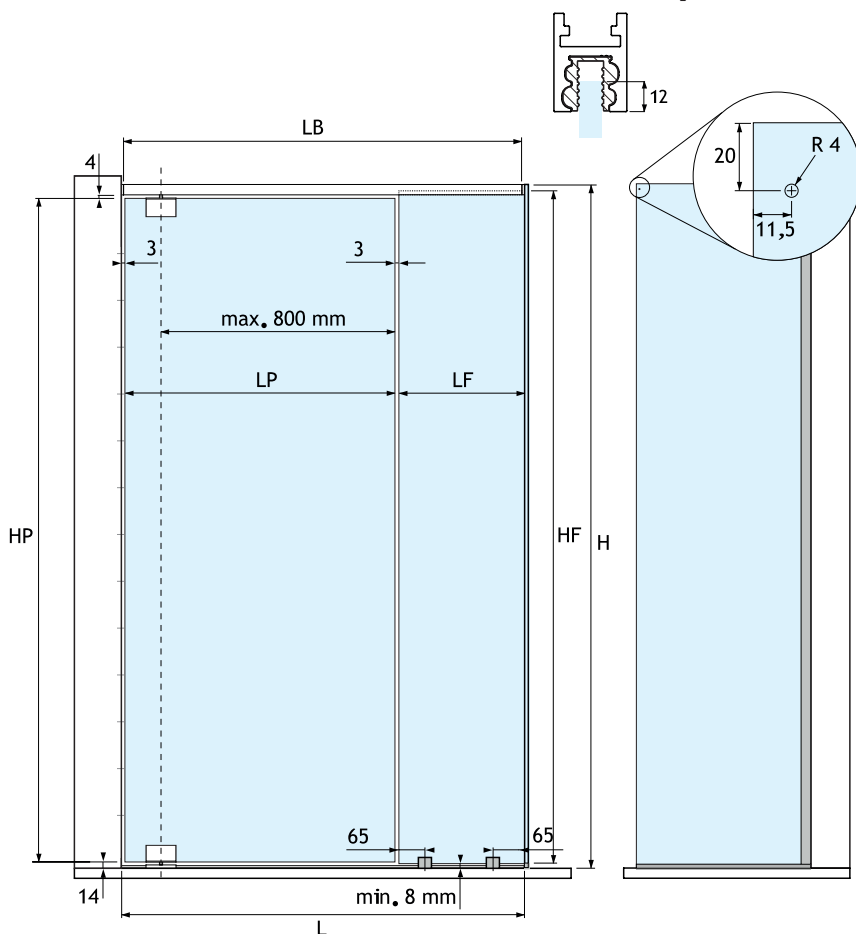
DIMENSIONAMENTO FISSAGGIO VETRO/MURO CON FISSO FRONTALE**DIMENSIONAMENTO ORIZZONTALE**

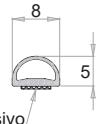
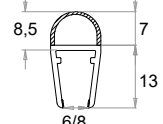
SENZA GUARNIZIONI	GUARNIZIONE a PALLONCINO ADESIVO (cod. 80124045)	GUARNIZIONE a PALLONCINO ad INCASTRO (cod. 80124001)
	 Biadesivo	
LP= L-6 mm	LP= L-8 mm	LP= L-18 mm
HP= H-49 mm	HP= H-49 mm	HP= H-49 mm
LB= L-15 mm	LB= L-15 mm	LB= L-15 mm
HF= H-27	HF= H-27	HF= H-27

FISSAGGIO VETRO/VETRO

Terminale regolabile per il fissaggio a vetro
 Cerniere a scatto con rotazione a 360°
 Blocco dell'anta a +90°, -90°, 180°

Guarnizioni e maniglia escluse

Materiale: profili in alluminio
 cerniere in ottone

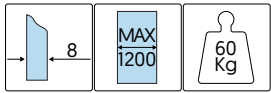
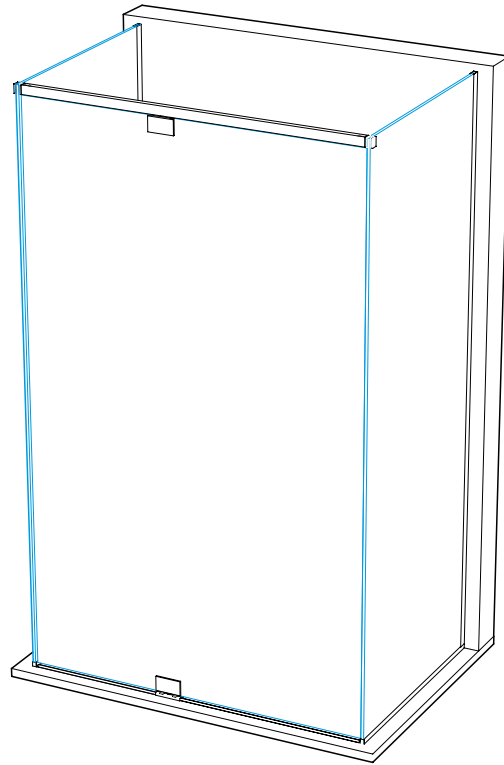

Codice

80128509





80128529

Finitura

Cromo lucido

Nero opaco

COMPONENTI INCLUSI NEL KIT

Profilo superiore  L= 1500 mm	Profilo tampone  L= 1500 mm
Attacco a muro  x2 pz	Diga ribassata  L= 1500 mm
Cerniera superiore  x1 pz	Cerniera inferiore  x1 pz
Profilo verticale  L= 2200 mm x2 pz	Profilo ad U per spalla con tappo  L=2000 mm
Terminale per spalla in vetro  x2 pz	

DIMENSIONAMENTO FISSAGGIO VETRO/VETRO

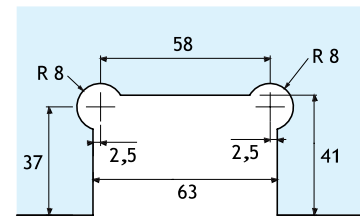
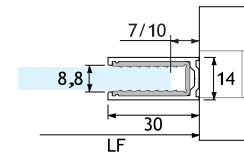
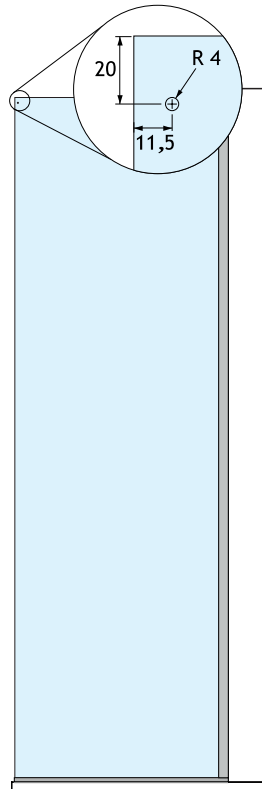
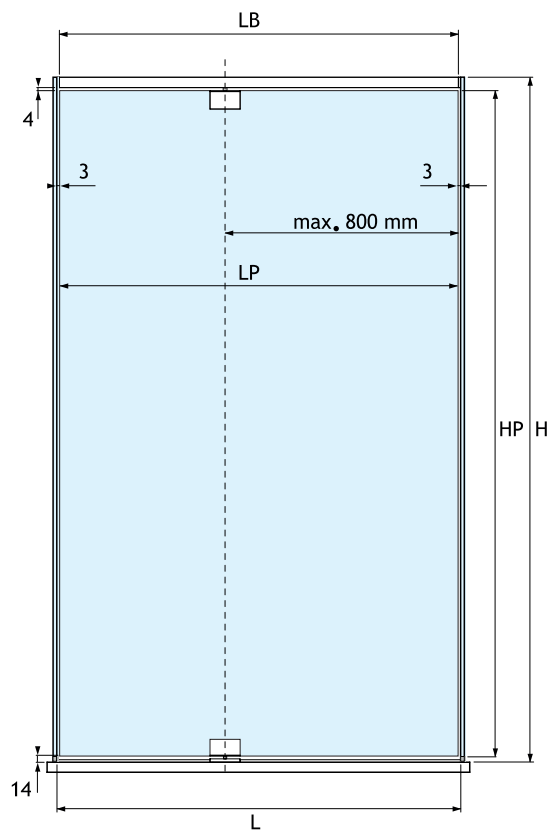

DIMENSIONAMENTO ORIZZONTALE

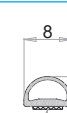
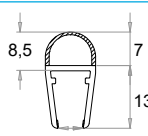
SENZA GUARNIZIONI	GUARNIZIONE a PALLONCINO ADESIVO [cod. 80124045]	GUARNIZIONE a PALLONCINO ad INCASTRO [cod. 80124001]
		
LP= L-6 mm	LP= L-8 mm	LP= L-18 mm
HP= H-49 mm	HP= H-49 mm	HP= H-49 mm
LB= L-15 mm	LB= L-15 mm	LB= L-15 mm

BOX DOCCIA

SMART GLASS **BD-B**
FISSAGGIO VETRO/VETRO CON FISSO FRONTALE

Terminale regolabile per il fissaggio a vetro

Cerniere a scatto con rotazione a 360°

Blocco dell'anta a +90°, -90°, 180°

Guarnizioni e maniglia escluse

 Materiale: profili in alluminio
 cerniere in ottone

Codice
Finitura
80128511

Cromo lucido

80128531

Nero opaco

COMPONENTI INCLUSI NEL KIT

Profilo superiore L= 2000 mm	Profilo tampone L= 2000 mm
Attacco a muro x2 pz	Diga ribassata L= 2000 mm
Cerniera superiore x1 pz	Cerniera inferiore x1 pz
Profilo verticale L= 2200 mm x2 pz	Profilo ad U per spalla con tappo L=2000 mm
Terminale per spalla in vetro x2 pz	Morsetto per vetro fisso x2 pz
Guarnizione per anta fissa L= 1000 mm	

DIMENSIONAMENTO FISSAGGIO VETRO/VETRO CON FISSO FRONTALE
DIMENSIONAMENTO ORIZZONTALE

SENZA GUARNIZIONI	GUARNIZIONE a PALLONCINO ADESIVO (cod. 80124045)	GUARNIZIONE a PALLONCINO ad INCASTRO (cod. 80124001)
LP= L-6 mm	LP= L-8 mm	LP= L-18 mm
HP= H-49 mm	HP= H-49 mm	HP= H-49 mm
LB= L-15 mm	LB= L-15 mm	LB= L-15 mm
HF= H-27	HF= H-27	HF= H-27

122

Riferimento listino pag. 18







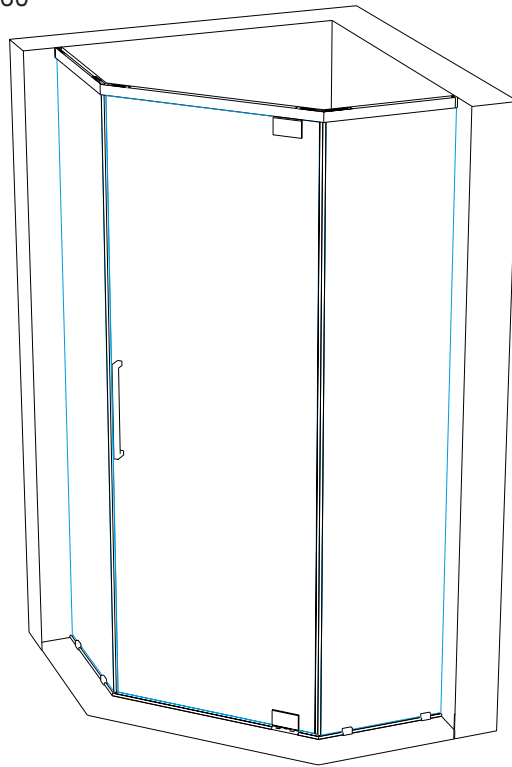

MONTAGGIO PERSONALIZZATO CON ANGOLO A 135° O VARIABILE

Comunicare le dimensioni del vano al momento dell'ordine
 Calcolo delle componenti in base alla realizzazione finale
 Terminale regolabile per il fissaggio a muro e vetro
 Cerniere a scatto con rotazione a 360°
 Blocco dell'anta a +90°, -90°, 180°

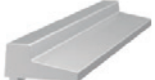
Guarnizioni e maniglia escluse

Materiale: profili in alluminio
 cerniere in ottone



COMPONENTI INCLUSI NEL KIT	
Profilo superiore  L= xxxx mm	Profilo tampone  L= xxxx mm
Attacco a muro  x2 pz	Diga ribassata  L= xxxx mm
Cerniera superiore  x1 pz	Cerniera inferiore  x1 pz
Connettore a 135°  x2 pz	Morsetto per vetro fisso  x4 pz
Guarnizione per anta fissa  L= xxxx mm	

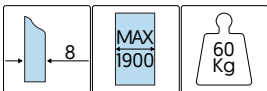





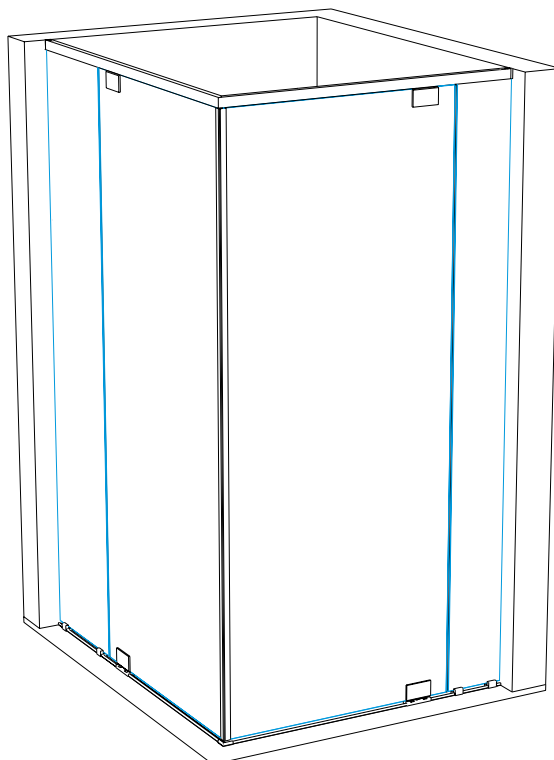

MONTAGGIO PERSONALIZZATO CON ANGOLO A 90°

Comunicare le dimensioni del vano al momento dell'ordine
 Calcolo delle componenti in base alla realizzazione finale
 Terminale regolabile per il fissaggio a muro e vetro
 Cerniere a scatto con rotazione a 360°
 Blocco dell'anta a +90°, -90°, 180°

Guarnizioni e maniglia escluse

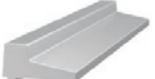
Materiale: profili in alluminio
 cerniere in ottone



COMPONENTI INCLUSI NEL KIT	
Profilo superiore  L= xxxx mm	Profilo tampone  L= xxxx mm
Attacco a muro  x2 pz	Diga ribassata  L= xxxx mm
Cerniera superiore  x1 pz	Cerniera inferiore  x1 pz
Connettore a 90°  x2 pz	Morsetto per vetro fisso  x4 pz
Guarnizione per anta fissa  L= xxxx mm	

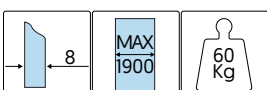

PROFILO SUPERIORE

Profilo principale per chiusure docce
 Predisposizione alloggiamento per vetro fisso
 Lunghezza profilo: 1500 o 2000 mm
 Materiale: lega di alluminio

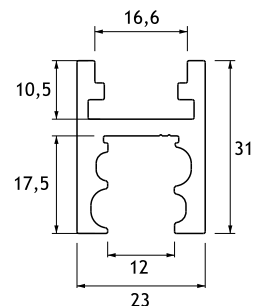
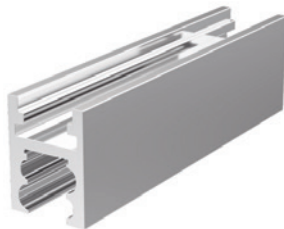
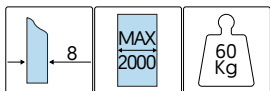

Codice	Lunghezza	Finitura
80128701	1500 mm	Anodizzato lucido
80128703	1500 mm	Anodizzato nero
80128705	2000 mm	Anodizzato lucido
80128707	2000 mm	Anodizzato nero

PROFILO TAMPONE

Profilo tampone per rifinire la sede del vetro fisso
 Chiusura a scatto
 Lunghezza profilo: 1500 o 2000 mm
 Materiale: lega di alluminio

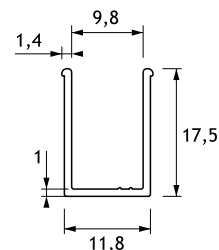
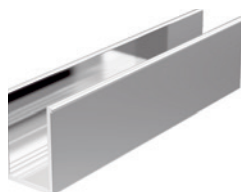

Codice	Lunghezza	Finitura
80128711	1500 mm	Anodizzato lucido
80128713	1500 mm	Anodizzato nero
80128715	2000 mm	Anodizzato lucido
80128717	2000 mm	Anodizzato nero

GUARNIZIONE PER VETRO FISSO

Guarnizione per vetro fisso
 Da inserire nel profilo superiore
 Vendita al metro
 Materiale: estruso in PVC trasparente

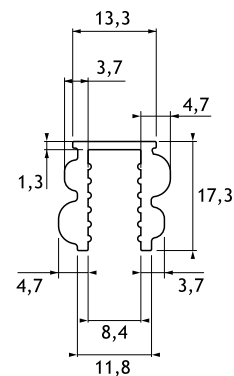

Codice
80128709

TERMINALE DI FISSAGGIO

Terminale regolabile per fissaggio a parete del profilo superiore
 Per fissaggio a vetro abbinare il relativo tappo terminale
 Completo di viti di fissaggio
 Materiale: alluminio e ottone

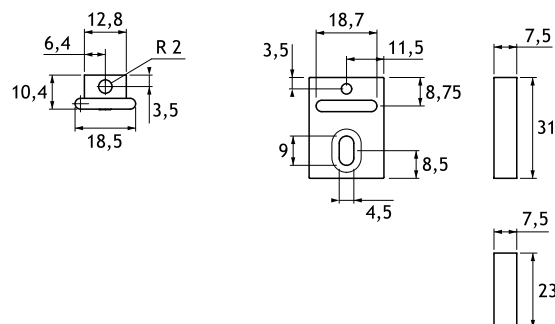

Codice	Finitura
80128719	Cromo lucido
80128721	Nero opaco

TAPPO PER FISSAGGIO A VETRO

Da utilizzarsi per fissaggi con spalla in vetro
 Reversibile destro/sinistro
 Completo di vite di fissaggio
 Da abbinare al terminale regolabile a muro
 Materiale: lega di alluminio

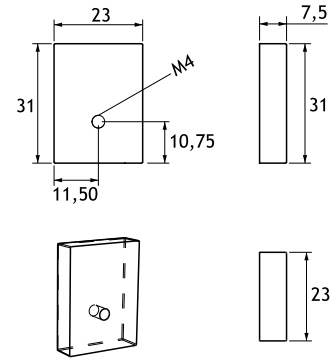

Codice	Finitura
80128723	Anodizzato lucido
80128725	Anodizzato nero

DAM HIGH - CANALINA AD "U" SAGOMATA

Canalina per fissaggio a pavimento del vetro laterale
 Materiale: lega di alluminio

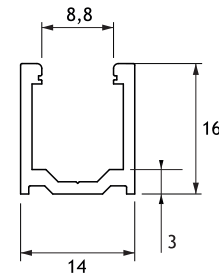
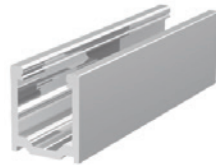

Codice	Lunghezza	Finitura
80125053	1500 mm	Anodizzato lucido
80125054	1500 mm	Anodizzato nero
80125055	2200 mm	Anodizzato lucido
80125056	2200 mm	Anodizzato nero

PROFILO VERTICALE

Profilo fermavetro per fissaggio e compensazione verticale
 Si utilizza senza silicone grazie alla guarnizione interna
 Lunghezza profilo: 2200 mm
 Materiale: lega di alluminio

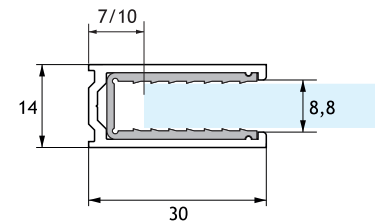

Codice	Finitura
80125051	Anodizzato lucido
80125052	Anodizzato nero

FIXI - MORSETTO PER VETRI FISSI

Morsetto a slitta per sostegno vetro fisso con sede per diga ribassata
 Non richiede foratura del vetro
 Fissaggio con grani
Utilizzare esclusivamente con diga ribassata
 Materiale: Acciaio inox Aisi 304

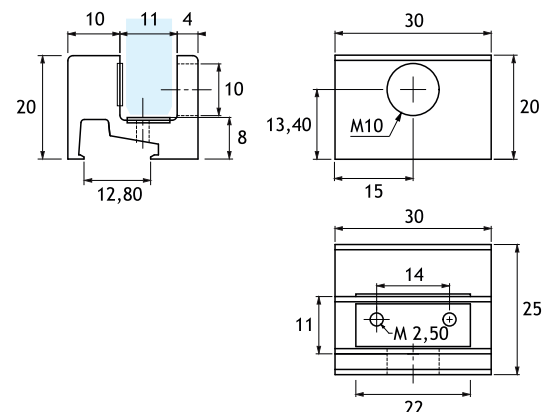

Codice	Finitura
80125077	Inox lucido
80125078	Nero opaco

DAM LOW - DIGA RIBASSATA

Diga ribassata di contenimento

Da fissare con silicone o biadesivo resistente all'acqua

Materiale: estruso di alluminio

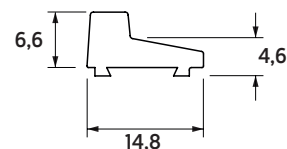
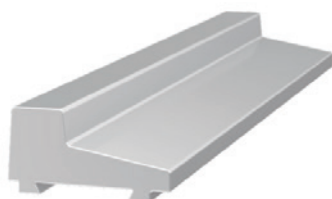

Codice	Lunghezza	Finitura
80125057	2200 mm	Anodizzato lucido
80125058	2200 mm	Anodizzato nero

GUARNIZIONE A PALLONCINO

Lunghezza profilo: 2200 mm

Materiale: pvc trasparente

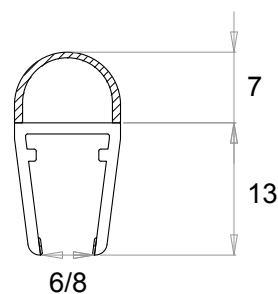
**Codice**

80124001

GUARNIZIONE A PALLONCINO ADESIVA SEMI-RIGIDA

Adesivo Tesa altamente performante per tenuta, trasparenza e resistenza ad acqua ed agenti atmosferici

Lunghezza profilo: 2500 mm

Materiale: termoplastico coestruso trasparente

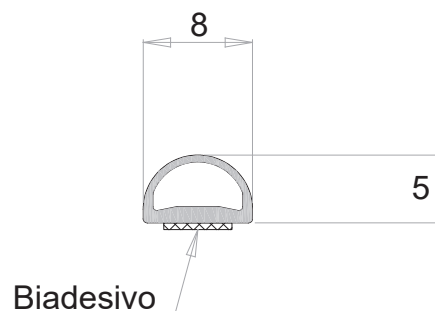
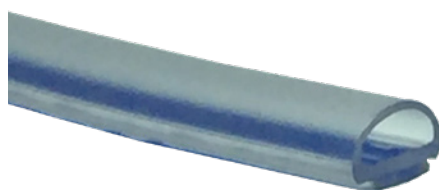
**Codice**

80124045

CERNIERA A BILICO SUPERIORE

Predisposta per l'uso con il profilo superiore BD
 Rotazione a 360°
 Blocco dell'anta a 0°, ± 90°, 180°
 Materiale: ottone

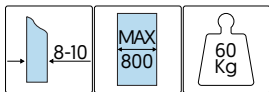
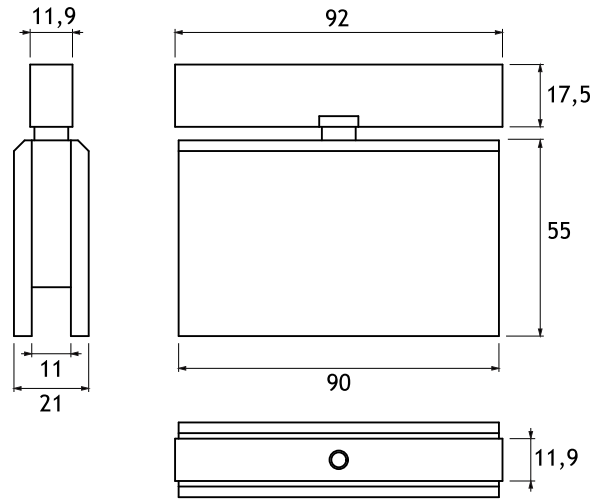

Codice	Finitura
80128741	Cromo lucido
80128743	Nero opaco

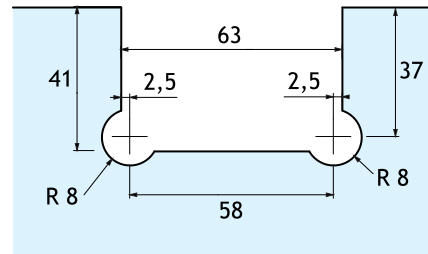

CERNIERA A BILICO INFERIORE

Predisposta per l'uso con il profilo diga ribassata
 Rotazione a 360°
 Blocco dell'anta a 0°, ± 90°, 180°
 Materiale: ottone

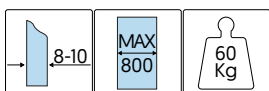
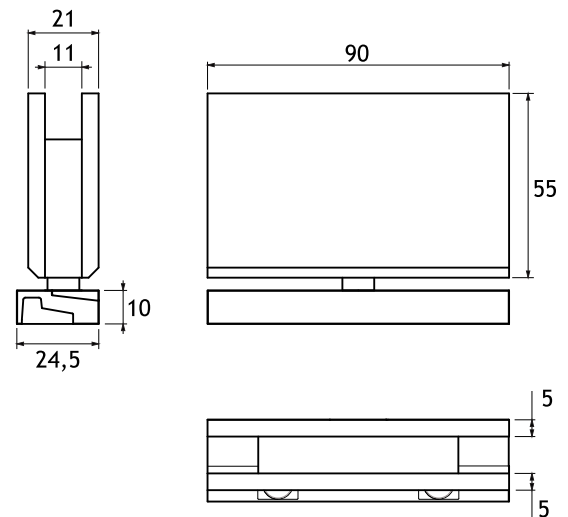

Codice	Finitura
80128745	Cromo lucido
80128747	Nero opaco

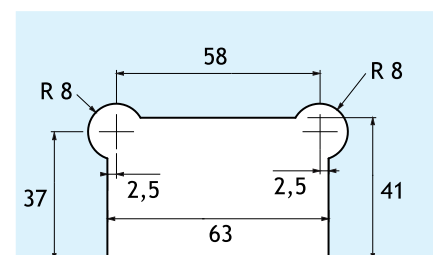

CONNETTORE A 90°

Connettore fisso per profilo superiore BD

Completo di viti di fissaggio

Materiale: ottone

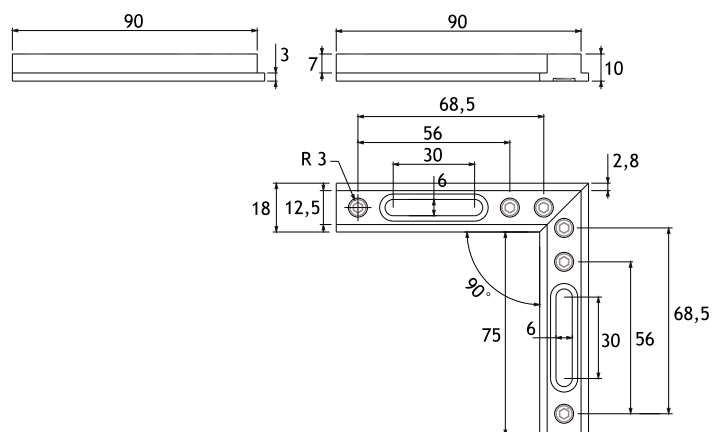
**Codice**

80128727

CONNETTORE A 135°

Connettore fisso per profilo superiore BD

Completo di viti di fissaggio

Materiale: ottone

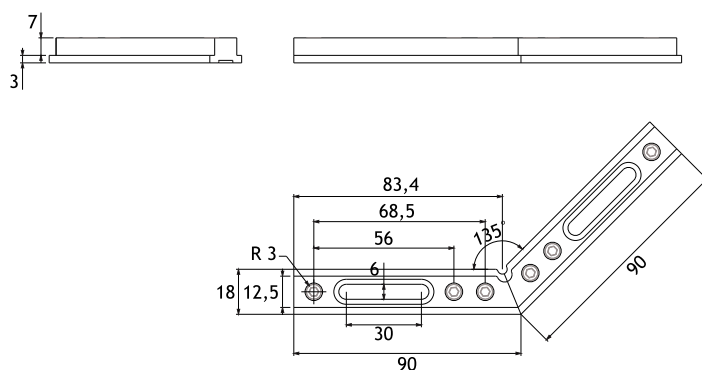
**Codice**

80128729

CONNETTORE REGOLABILE

Connettore regolabile per profilo superiore BD

Completo di viti di fissaggio

Materiale: ottone

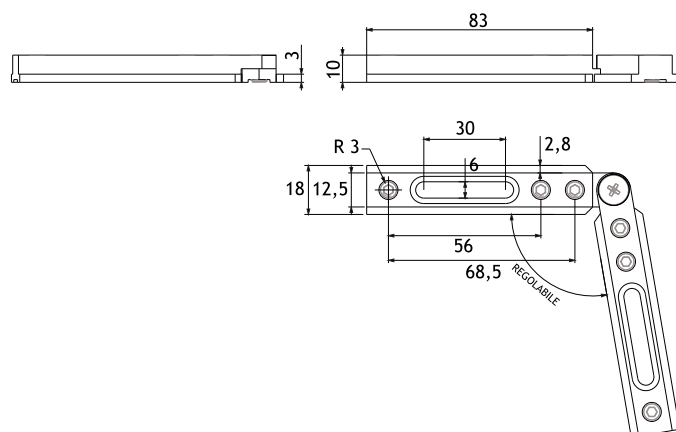
**Codice**

80128731



BD-S SYSTEM



BD-S è un sistema che offre la possibilità di realizzare ante apribili a libro di ampie dimensioni.

La guida scorrevole e il carrello a doppia ruota supportano il peso delle ante con un movimento fluido e preciso.

Il morsetto del carrello di scorrimento sganciabile (optional) consente l'apertura di emergenza del box doccia, se necessario.

Completano il sistema le cerniere a scatto regolabili "COVER" da fissare a parete e le cerniere Vetro/Vetro prive del meccanismo di alzata.

Le cerniere, che ben si abbinano tra loro a livello estetico, consentono la chiusura a libro e la possibilità di scelta tra un'apertura a tirare o a spingere.

È inoltre possibile inserire dei vetri fissi in linea con l'anta battente, grazie ai morsetti realizzati appositamente per il fissaggio nella diga ribassata.

I kit vengono forniti con profili da 1500 mm o 2000mm e sono completi di attacchi e accessori per il montaggio.

Maniglie e guarnizioni sono escluse.

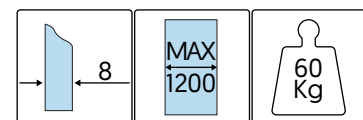

FISSAGGIO MURO/MURO

Terminale regolabile per il fissaggio a muro

Cerniere a scatto senza viti in vista

Cerniere Vetro/Vetro reversibili con apertura a tirare o spingere

Guarnizioni e maniglia escluse

Materiale: profili in alluminio
cerniere in ottone

CONSIGLIATA
Maniglia 40x40 adesiva



80023099 Inox lucido
80023101 Nero opaco

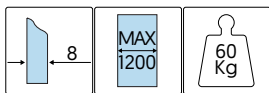
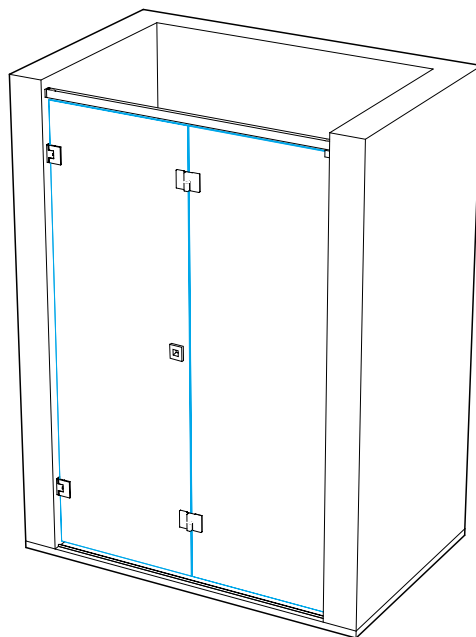

Codice	Verso cerniere	Finitura
80128601	DX	Cromo lucido
80128603	SX	Cromo lucido
80128621	DX	Nero opaco
80128623	SX	Nero opaco

COMPONENTI INCLUSI NEL KIT

Profilo superiore  L= 1500 mm	Carrello con morsetto  x1 pz
Attacco a muro  x2 pz	Diga ribassata  L= 1500 mm
Cerniera vetro/muro  x2 pz	Cerniera vetro/vetro  x2 pz
Guarnizione finecorsa  x1 pz	

LAVORAZIONI FISSAGGIO MURO/MURO

Per tacche delle cerniere vedi pag. 141

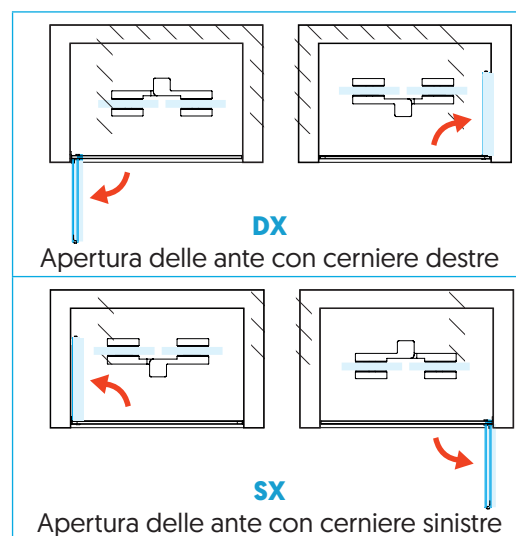
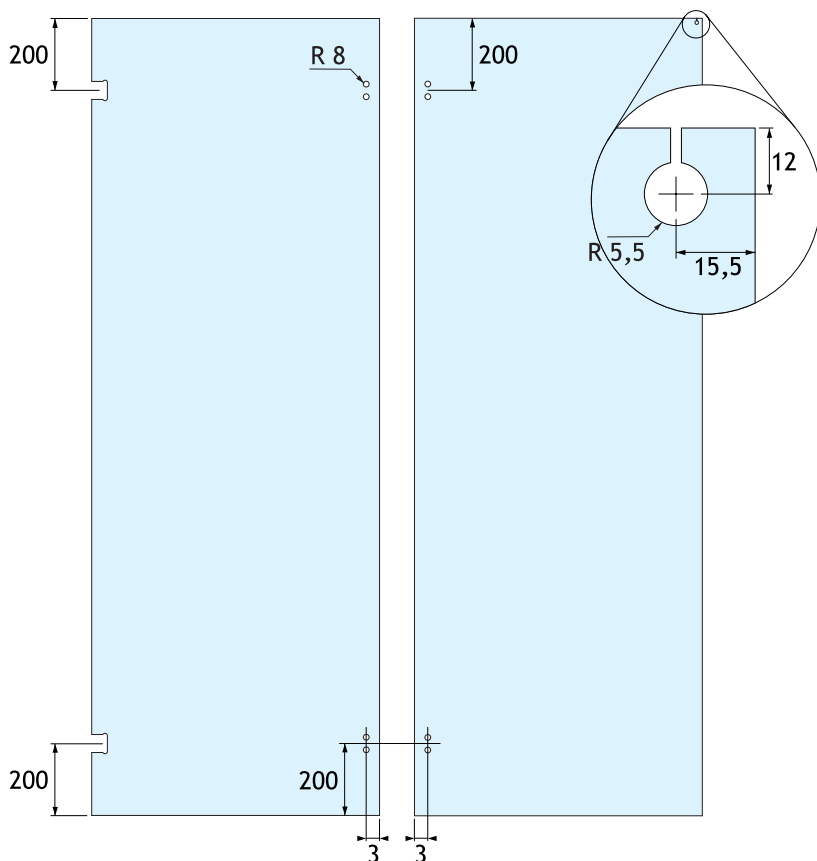

DIMENSIONAMENTO FISSAGGIO MURO/MURO

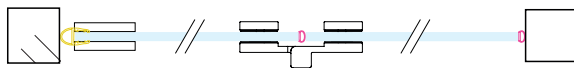
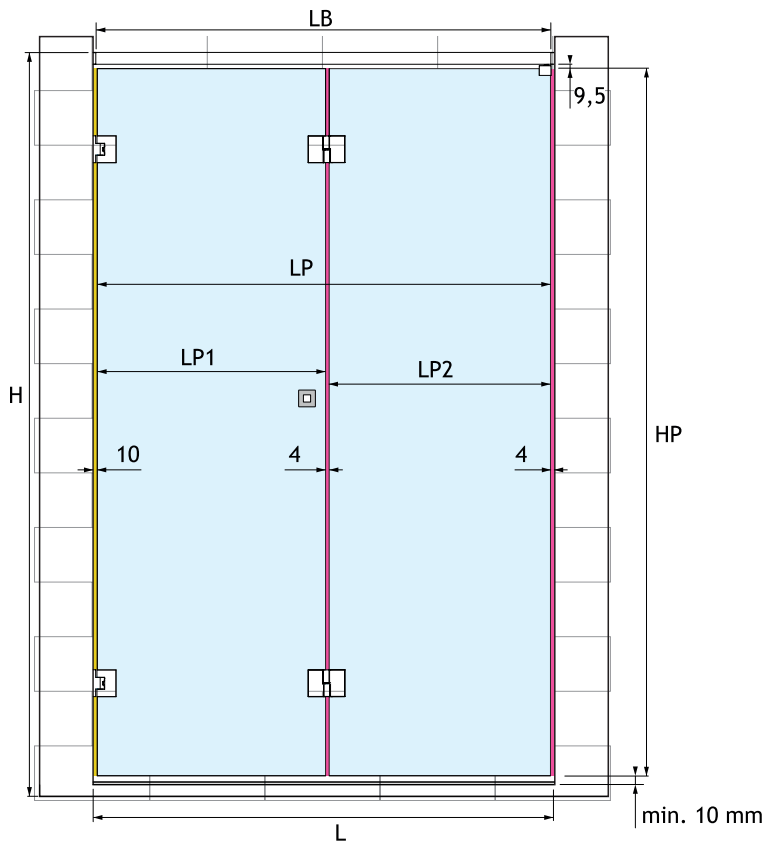

DIMENSIONAMENTO CON GUARNIZIONE A PALLONCINO ADESIVO (cod. 80124045)

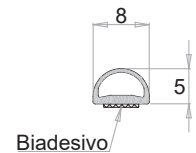

LP= L-14 mm

LP1= LP/2 -7 mm

LP2= LP/2 +3 mm

HP= H-50,5 mm

LB= L-15 mm

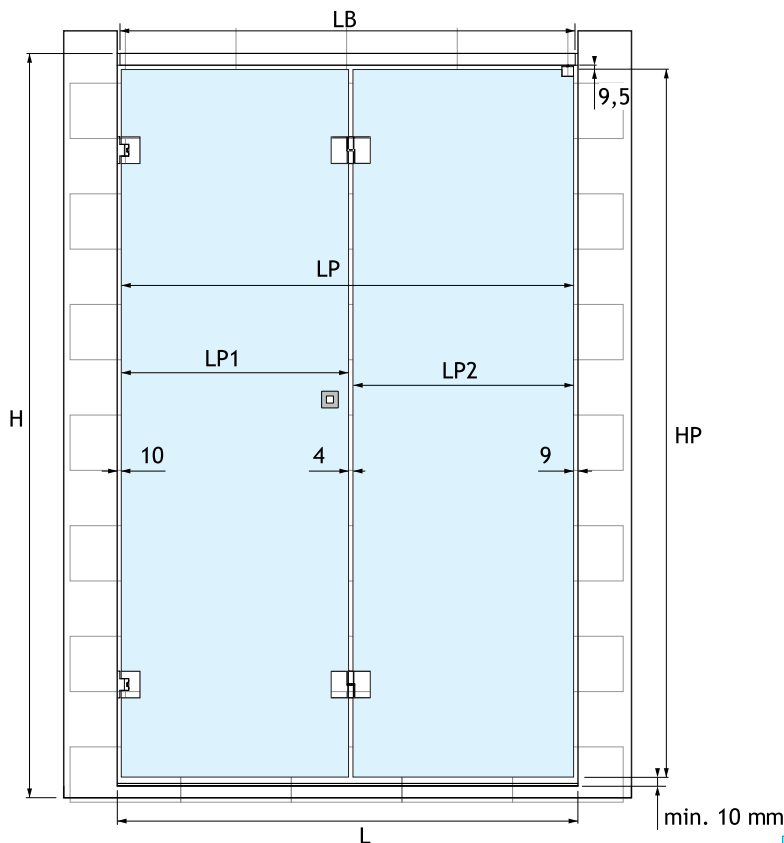

Codice 80124001

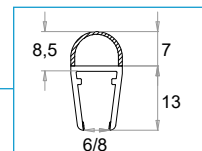

DIMENSIONAMENTO CON GUARNIZIONE a BATTUTA MORBIDA (cod. 80124033)

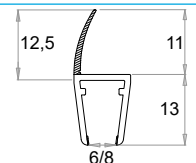

LP= L-19 mm

LP1= LP/2-7 mm

LP2= LP/2 +3 mm

HP= H-50,5 mm

LB= L-15 mm

FISSAGGIO MURO/MURO CON FISSO FRONTALE

Terminale regolabile per il fissaggio a muro

Cerniere a scatto senza viti in vista

Cerniere Vetro/Vetro reversibili con apertura a tirare o spingere

Guarnizioni e maniglia escluse

Materiale: profili in alluminio
cerniere in ottone

CONSIGLIATA
Maniglia 40x40 adesiva



80023099 Inox lucido
80023101 Nero opaco

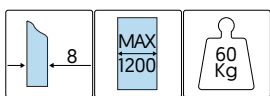

Codice	Verso cerniere	Finitura
80128611	DX	Cromo lucido
80128613	SX	Cromo lucido
80128631	DX	Nero opaco
80128633	SX	Nero opaco

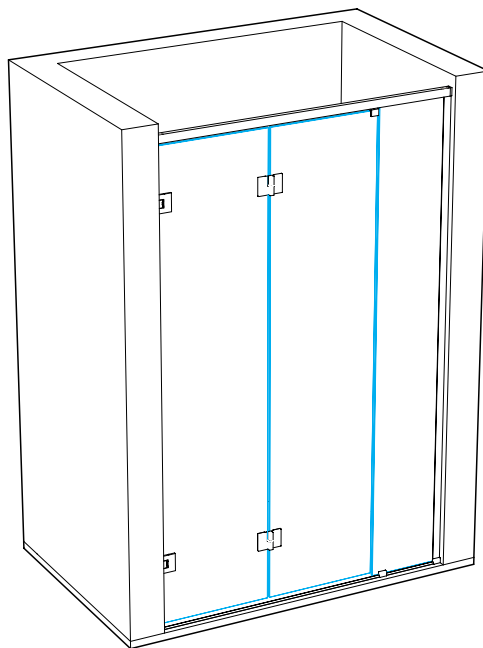

COMPONENTI INCLUSI NEL KIT

Profilo superiore  L=2000 mm	Carrello con morsetto  x1 pz
Attacco a muro  x2 pz	Diga ribassata  L= 2000 mm
Cerniera vetro/muro  x2 pz	Cerniera vetro/vetro  x2 pz
Guarnizione finecorsa  x1 pz	Morsetto per vetro fisso  x2 pz
Profilo verticale  L= 2200 mm	

LAVORAZIONI FISSAGGIO MURO/MURO CON FISSO FRONTALE

Per tacche delle cerniere vedi pag. 141

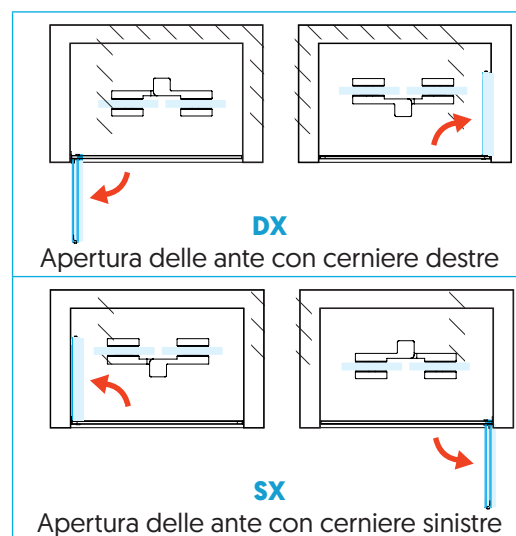
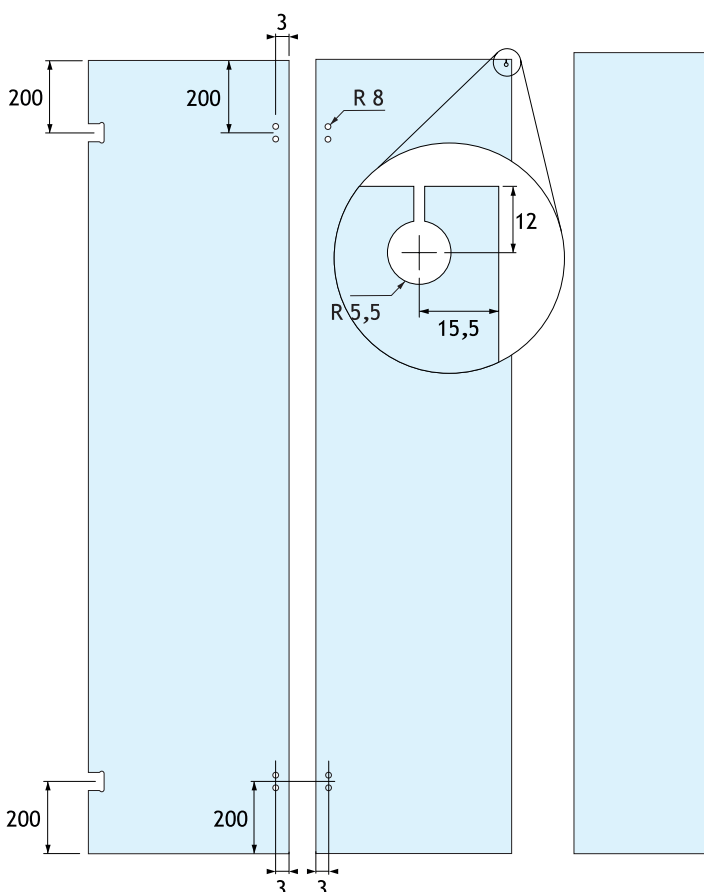

DIMENSIONAMENTO FISSAGGIO MURO/MURO CON FISSO FRONTALE

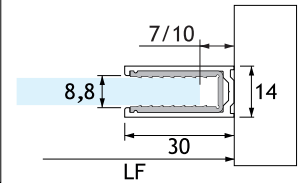
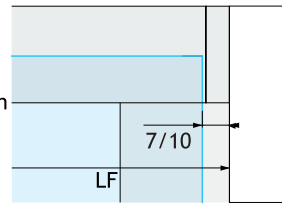
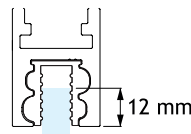
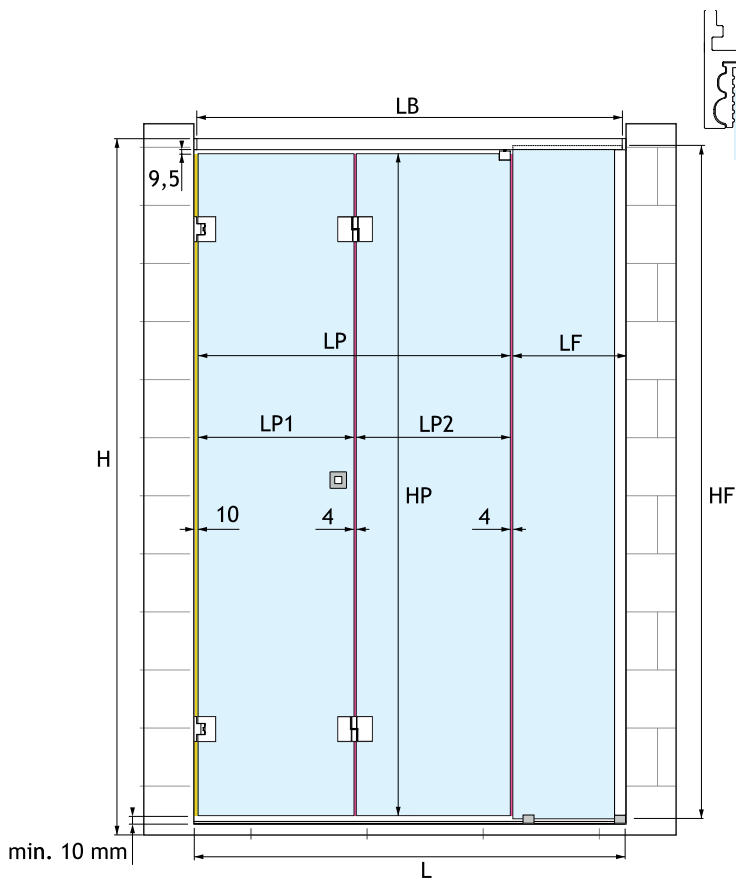

DIMENSIONAMENTO CON GUARNIZIONE A PALLONCINO ADESIVO (cod. 80124045)

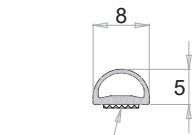

Biadesivo

LP= L-LF-14 mm

LP1= LP/2 -7 mm

LP2= LP/2 +3 mm

HP= H-50,5 mm

LB= L-15 mm

HF= H-27 mm

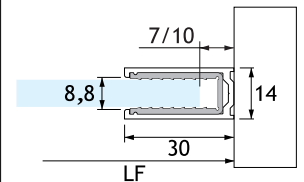
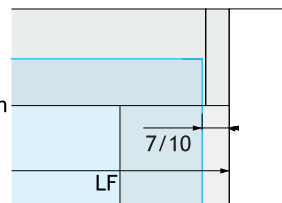
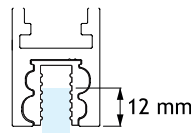
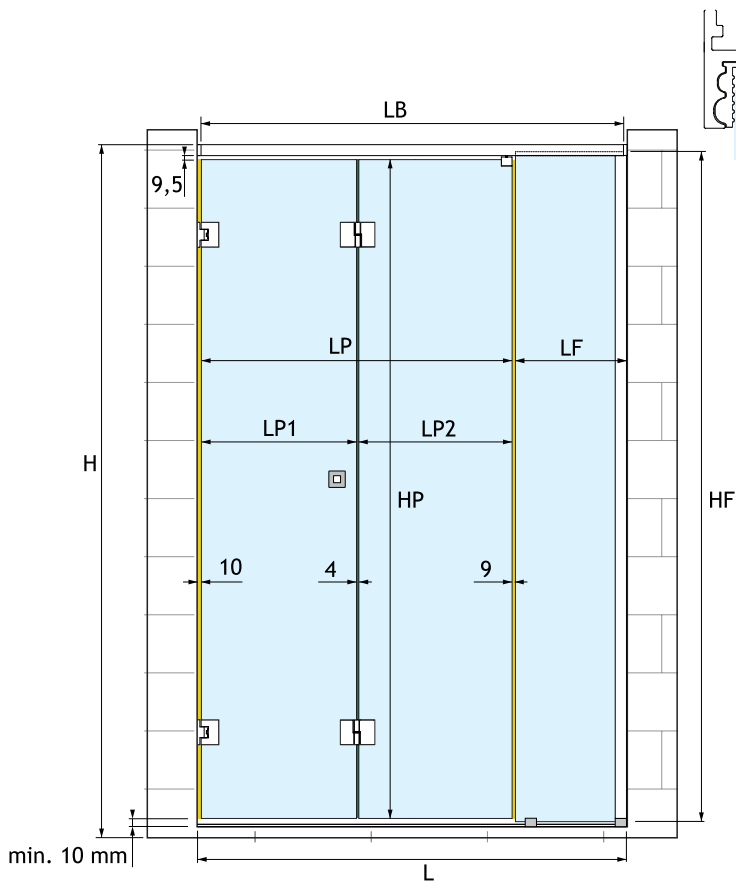
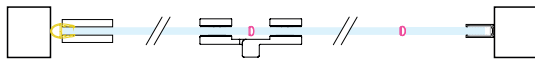

DIMENSIONAMENTO CON GUARNIZIONE a BATTUTA MORBIDA (cod. 80124033)

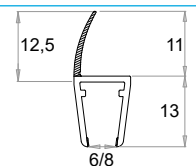

LP= L-19 mm

LP1= LP/2 -7 mm

LP2= LP/2 +3 mm

HP= H-50,5 mm

LB= L-15 mm

HF= H-27 mm

Codice 80124001

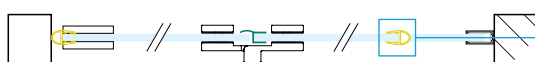
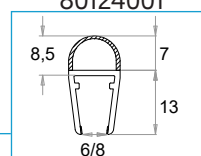

FISSAGGIO VETRO/MURO

Terminale regolabile per il fissaggio a muro e vetro
Cerniere a scatto senza viti in vista
Cerniere Vetro/Vetro reversibili con apertura a tirare o spingere

Guarnizioni e maniglia escluse

Materiale: profili in alluminio
cerniere in ottone

CONSIGLIATA
Maniglia 40x40 adesiva



80023099 Inox lucido
80023101 Nero opaco

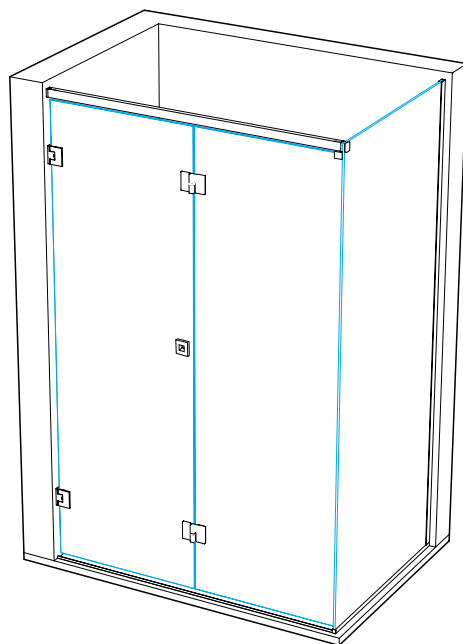
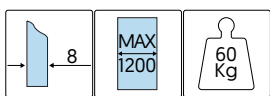

Codice	Verso cerniere	Finitura
80128605	DX	Cromo lucido
80128607	SX	Cromo lucido
80128625	DX	Nero opaco
80128627	SX	Nero opaco

COMPONENTI INCLUSI NEL KIT

Profilo superiore  L=2000 mm	Carrello con morsetto  x1 pz
Attacco a muro  x2 pz	Diga ribassata  L= 2000 mm
Cerniera vetro/muro  x2 pz	Cerniera vetro/vetro  x2 pz
Guarnizione finecorsa  x1 pz	Terminale per spalla in vetro  x1 pz
Profilo verticale  L= 2200 mm	Profilo ad U per spalla con tappo  L=1000 mm

LAVORAZIONI FISSAGGIO VETRO/MURO

Per tacche delle cerniere vedi pag. 141

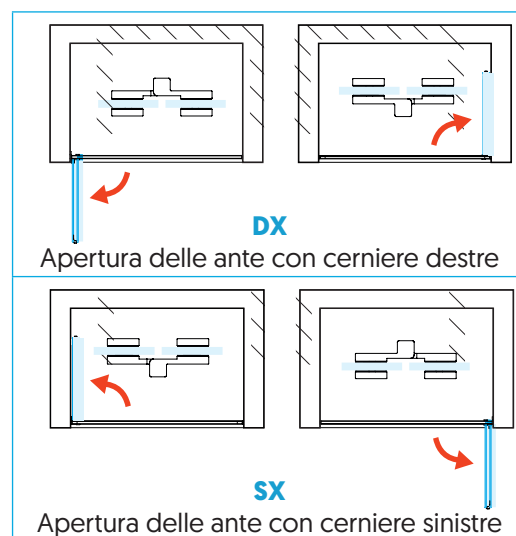
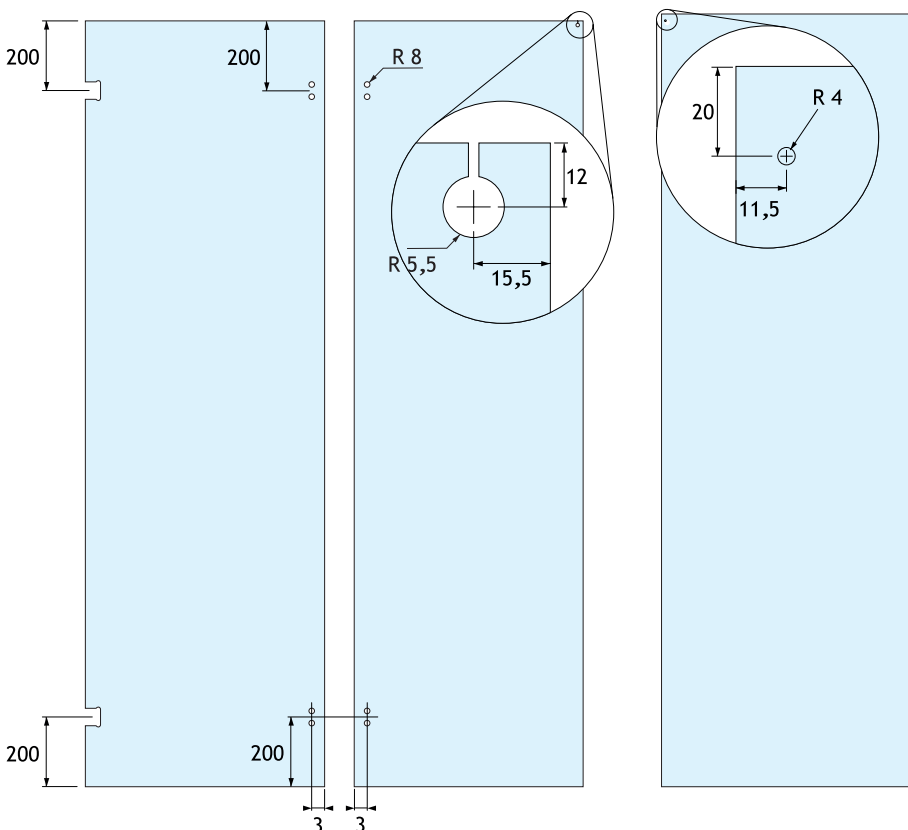

DIMENSIONAMENTO FISSAGGIO VETRO/MURO

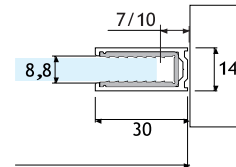
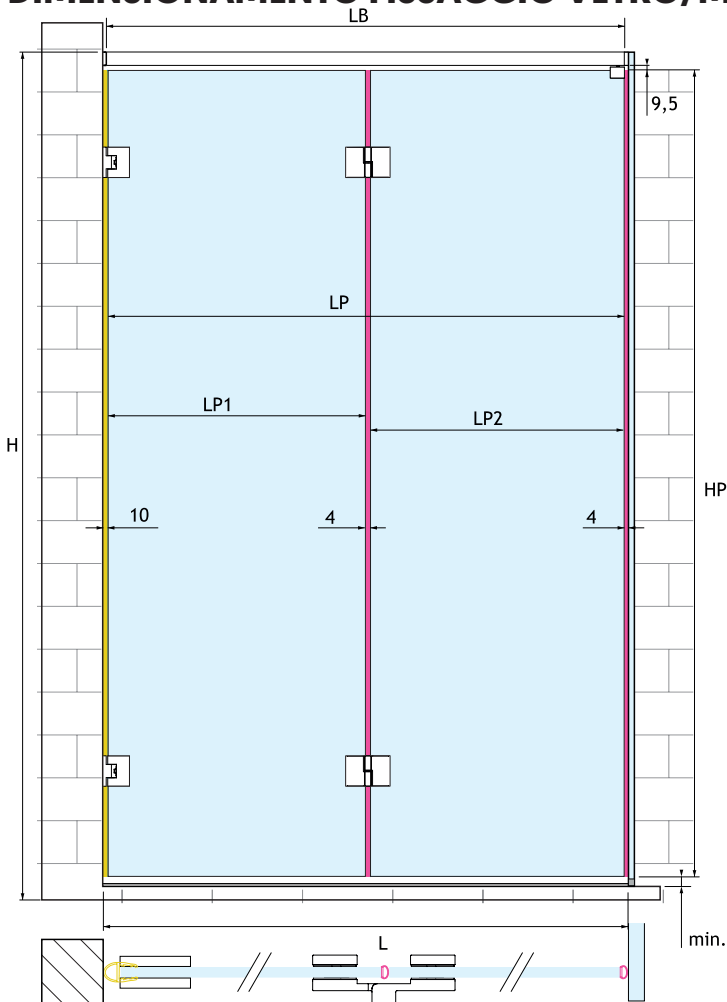

DIMENSIONAMENTO CON GUARNIZIONE A PALLONCINO ADESIVO
[cod. 80124045]



- LP= L-14 mm
- LP1= LP/2 -7 mm
- LP2= LP/2 +3 mm
- HP= H-50,5 mm
- LB= L-15 mm

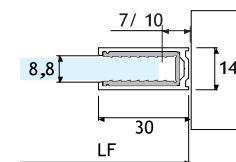
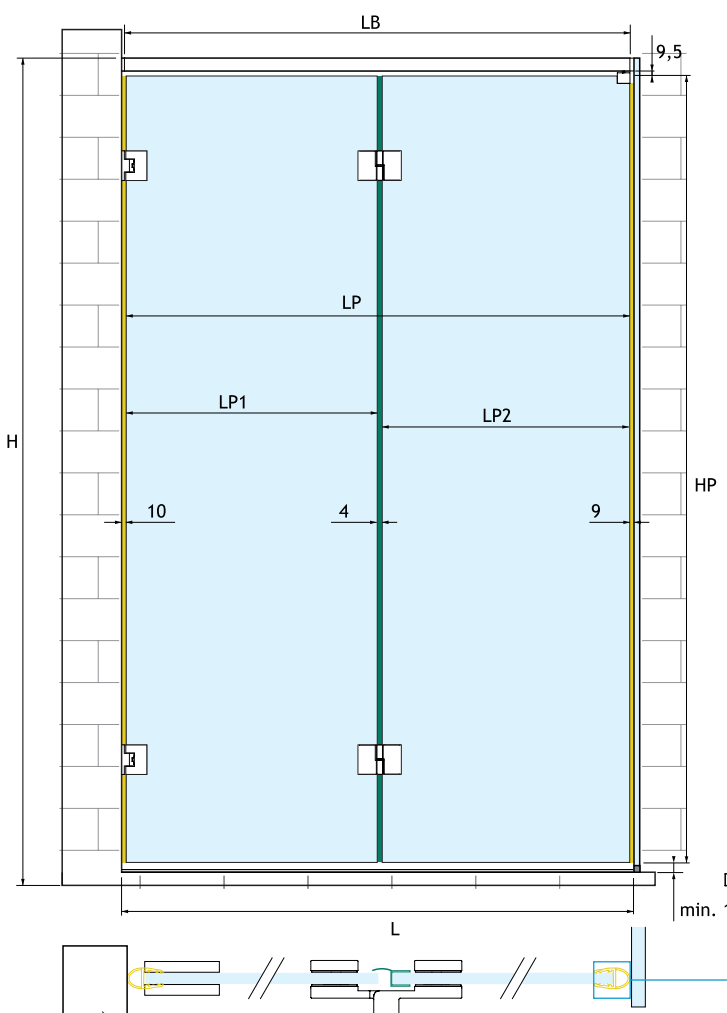

DIMENSIONAMENTO CON GUARNIZIONE a BATTUTA MORBIDA
[cod. 80124033]

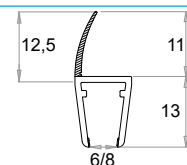

- LP= L-19 mm
- LP1= LP/2 -7 mm
- LP2= LP/2 +3 mm
- HP= H-50,5 mm
- LB= L-15 mm

Codice 80124001

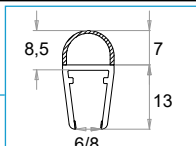

FISSAGGIO VETRO/MURO CON FISSO FRONTALE

Terminale regolabile per il fissaggio a muro e vetro

Cerniere a scatto senza viti in vista

Cerniere Vetro/Vetro reversibili con apertura a tirare o spingere

Guarnizioni e maniglia escluse

Materiale: profili in alluminio
cerniere in ottone

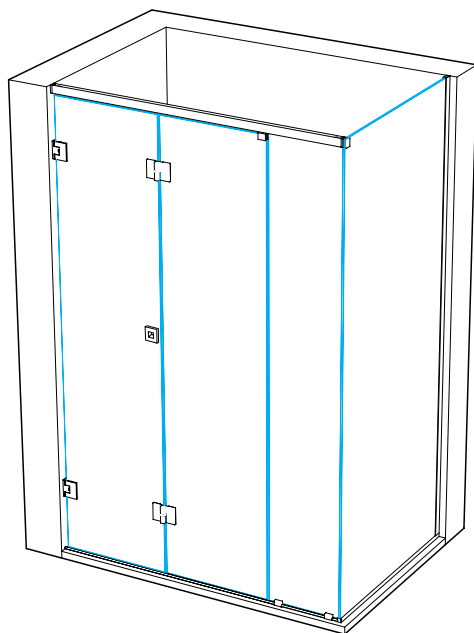

CONSIGLIATA

Maniglia 40x40 adesiva



80023099 Inox lucido

80023101 Nero opaco

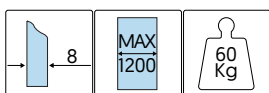

Codice

Verso cerniere

Finitura

80128615

DX

Cromo lucido

80128617

SX

Cromo lucido

80128635

DX

Nero opaco

80128637

SX

Nero opaco

COMPONENTI INCLUSI NEL KIT

Profilo superiore  L=2000 mm	Carrello con morsetto  x1 pz
Attacco a muro  x2 pz	Diga ribassata  L= 2000 mm
Cerniera vetro/muro  x2 pz	Cerniera vetro/vetro  x2 pz
Guarnizione finecorsa  x1 pz	Terminale per spalla in vetro  x1 pz
Profilo verticale  L= 2200 mm	Profilo ad U per spalla con tappo  L=1000 mm
Morsetto per vetro fisso  x1 pz	

LAVORAZIONI FISSAGGIO VETRO/MURO CON FISSO FRONTALE

Per tacche delle cerniere vedi pag. 141

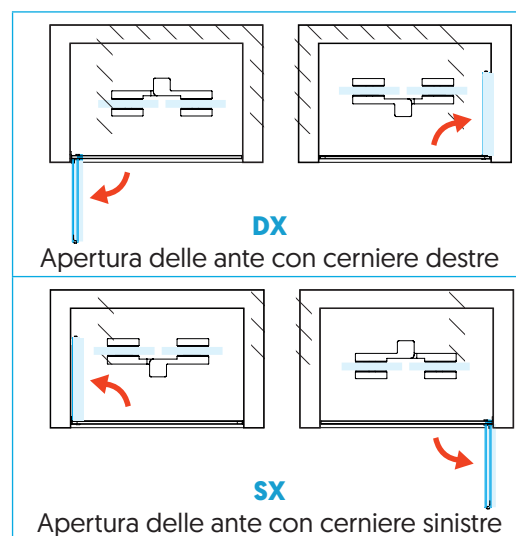
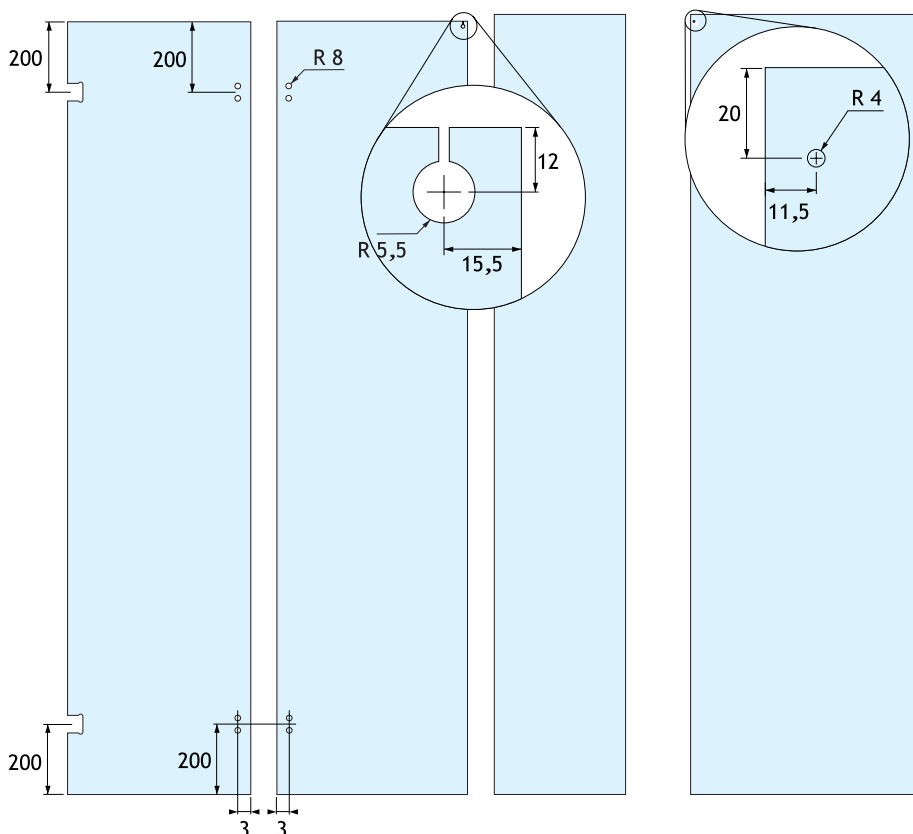

DIMENSIONAMENTO FISSAGGIO VETRO/MURO CON FISSO FRONTALE

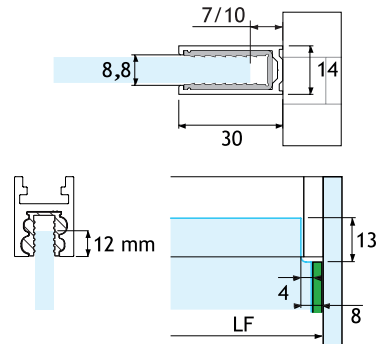
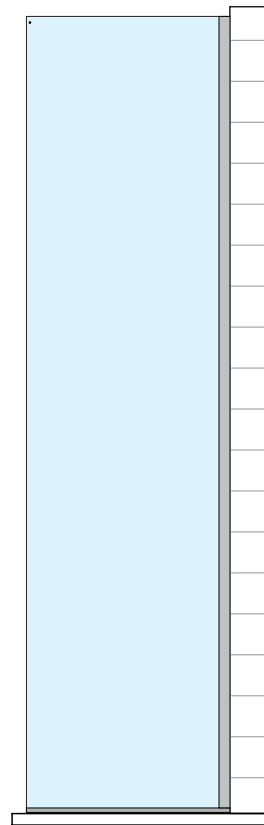
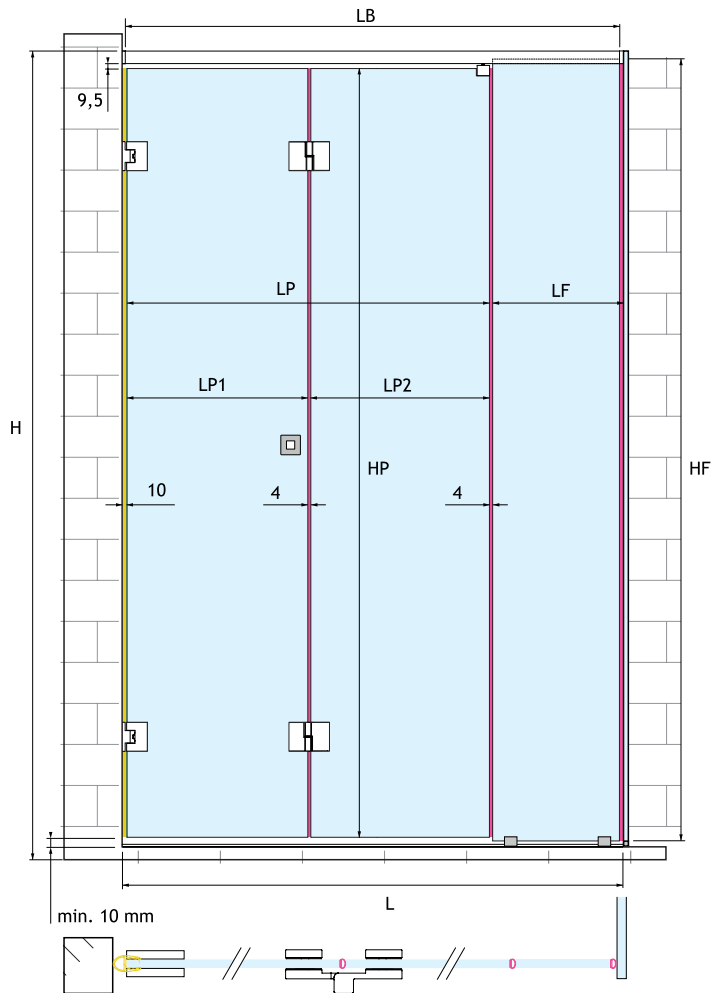

DIMENSIONAMENTO CON GUARNIZIONE A PALLONCINO ADESIVO (cod. 80124045)



- LP= L-LF-14 mm
- LP1= LP/2 -7 mm
- LP2= LP/2 +3 mm
- HP= H-50,5 mm
- LB= L-15 mm
- HF= H-27 mm

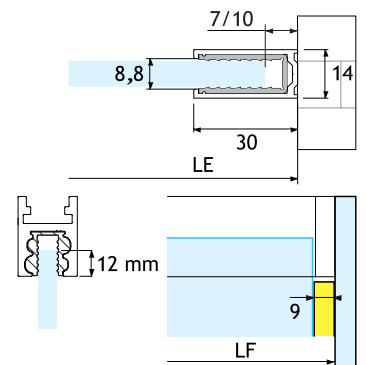
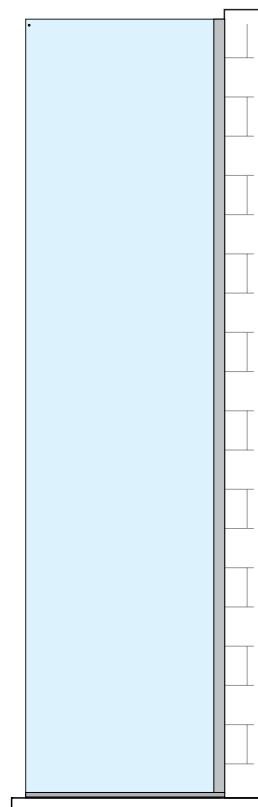
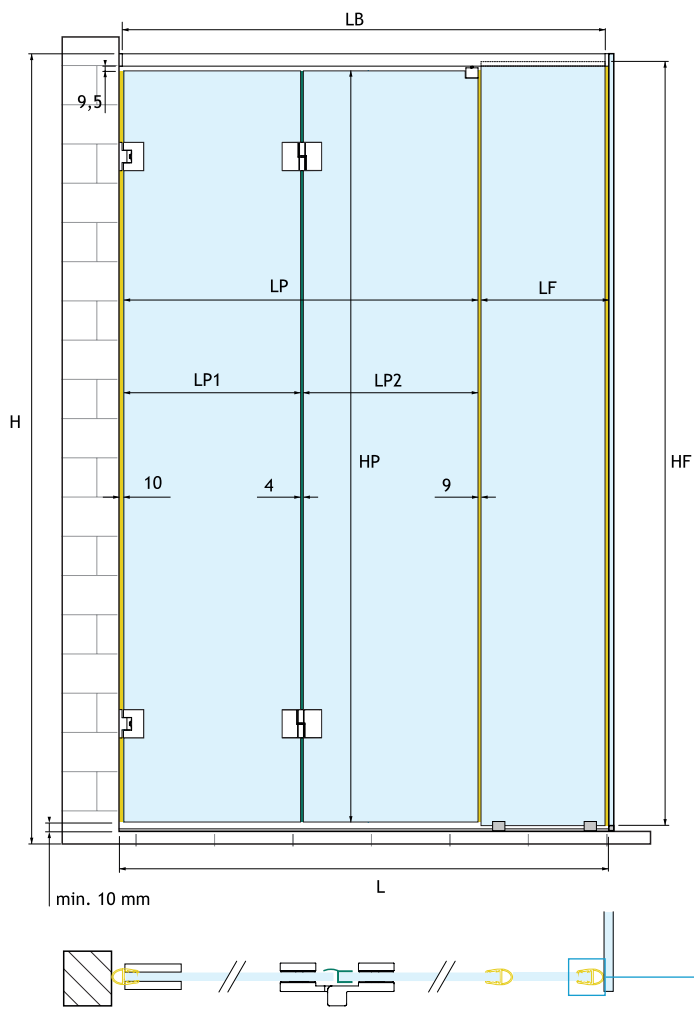

DIMENSIONAMENTO CON GUARNIZIONE a BATTUTA MORBIDA (cod. 80124033)

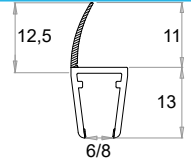

- LP= L-LF-19 mm
- LP1= LP/2 -7 mm
- LP2= LP/2 +3 mm
- HP= H-50,5 mm
- LB= L-15 mm
- HF= H-27 mm

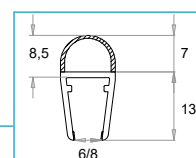

Codice 80124001

PROFILO SUPERIORE

Profilo principale per chiusure docce
 Predisposizione alloggiamento per vetro fisso
 Lunghezza profilo: 1500 mm o 2000 mm
 Materiale: lega di alluminio

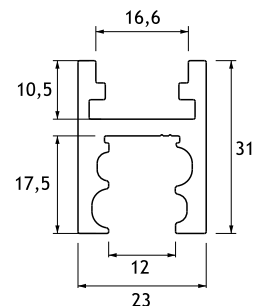
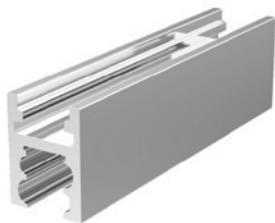
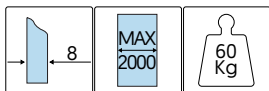

Codice	Lunghezza	Finitura
80128701	1500 mm	Anodizzato lucido
80128703	1500 mm	Anodizzato nero
80128705	2000 mm	Anodizzato lucido
80128707	2000 mm	Anodizzato nero

MORSETTO CON CARRELLO

Morsetto per vetro completo di carrello ad asse verticale
 Movimento silenzioso su doppi cuscinetti a sfera
 Materiale: lega di alluminio

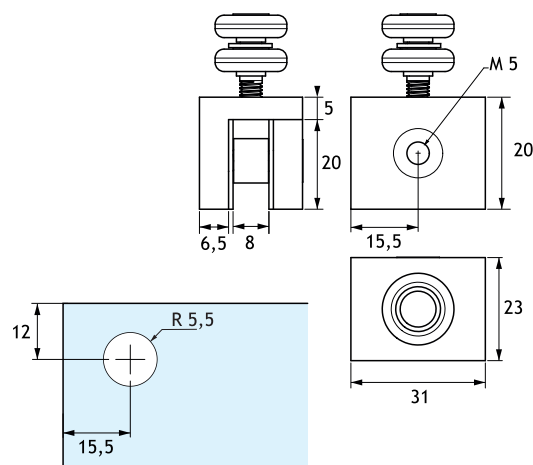
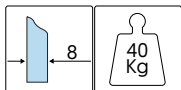

Codice	Finitura
80128751	Anodizzato lucido
80128753	Anodizzato nero

GUARNIZIONE PER VETRO FISSO

Guarnizione per vetro fisso e come fine corsa per il carrello
 Da inserire nel profilo superiore
 Materiale: estruso in PVC trasparente

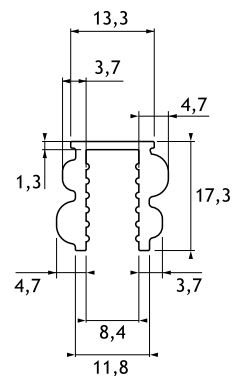

Codice
80128709

TERMINALE DI FISSAGGIO

Terminale regolabile per fissaggio a parete del profilo superiore
 Per fissaggio a vetro abbinare il relativo tappo terminale
 Completo di viti di fissaggio
 Materiale: alluminio e ottone

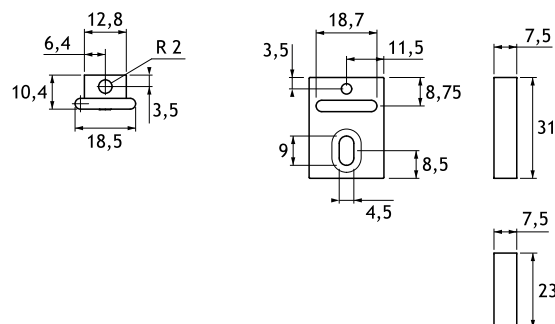

Codice	Finitura
80128719	Cromo lucido
80128721	Nero opaco

TAPPO PER FISSAGGIO A VETRO

Da utilizzarsi per fissaggi con spalla in vetro
 Reversibile destro/sinistro
 Completo di vite di fissaggio
Da abbinare al terminale regolabile a muro
 Materiale: lega di alluminio

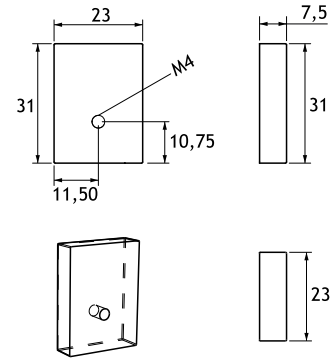

Codice	Finitura
80128723	Anodizzato lucido
80128725	Anodizzato nero

DAM HIGH - CANALINA AD "U" SAGOMATA

Canalina per fissaggio a pavimento del vetro laterale
 Materiale: lega di alluminio

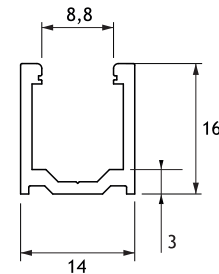
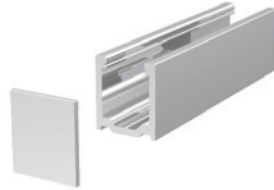

Codice	Lunghezza	Finitura
80125053	1500 mm	Anodizzato lucido
80125054	1500 mm	Anodizzato nero
80125055	2200 mm	Anodizzato lucido
80125056	2200 mm	Anodizzato nero

PROFILO VERTICALE

Profilo fermavetro per fissaggio e compensazione verticale
 Si utilizza senza silicone grazie alla guarnizione interna
 Lunghezza: 2200 mm
 Materiale: lega di alluminio

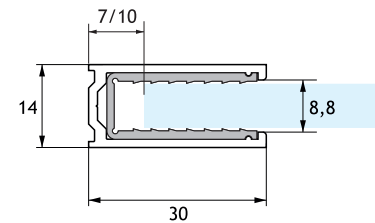

Codice	Finitura
80125051	Anodizzato lucido
80125052	Anodizzato nero

FIXI - MORSETTO PER VETRI FISSI

Morsetto a slitta per sostegno vetro fisso con sede per diga ribassata
 Non richiede foratura del vetro
 Fissaggio con grani
Utilizzare esclusivamente con diga ribassata
 Materiale: acciaio inox Aisi 304

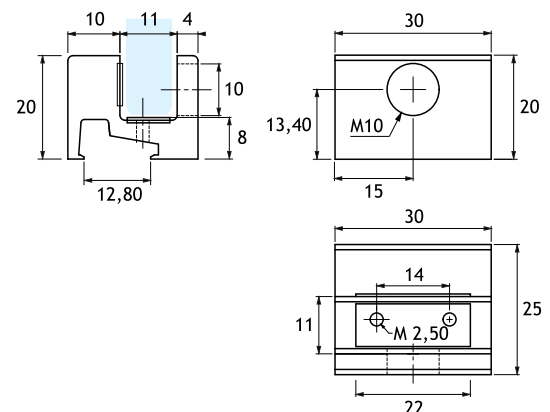

Codice	Finitura
80125077	Inox lucido
80125078	Nero opaco

DIGA RIBASSATA

Diga ribassata di contenimento
 Fissaggio con silicone o biadesivo resistente all'acqua
 Materiale: lega di alluminio

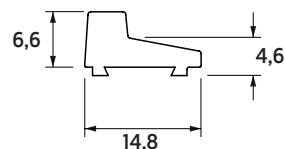
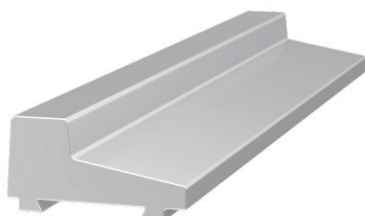

Codice	Lunghezza	Finitura
80125057	2200 mm	Anodizzato lucido
80125058	2200 mm	Anodizzato nero

MANIGLIA ADESIVA "BD-S"

Coppia di maniglie autoadesive ideate per sistemi BD-S
 Adesivo speciale 3M VHB ad alta resistenza
 Si consiglia di pulire il vetro con **DEXCLEAN 90** prima dell'applicazione
 Materiale: acciaio inox Aisi 304

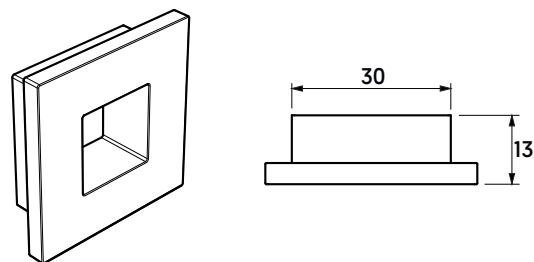
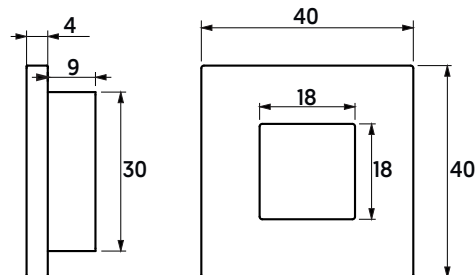
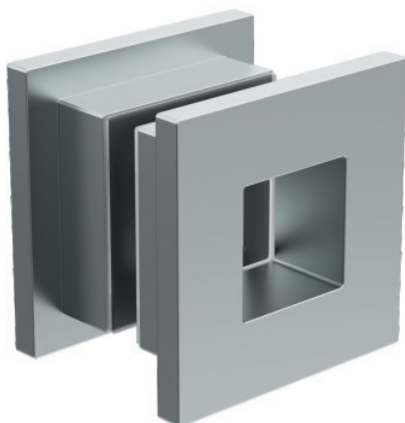

Codice	Finitura
80023099	Inox lucido
80023101	Nero opaco

CERNIERA REGOLABILE "COVER" - VETRO/MURO - PIASTRA LATERALE

Cerniera a scatto con regolazione angolare
 Completa di copertine, nessuna vite in vista
 Versione: Vetro/Muro - piastra laterale
 Blocco dell'anta a 0° ± 90°
 Materiale: ottone

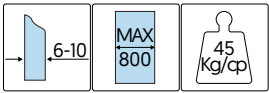
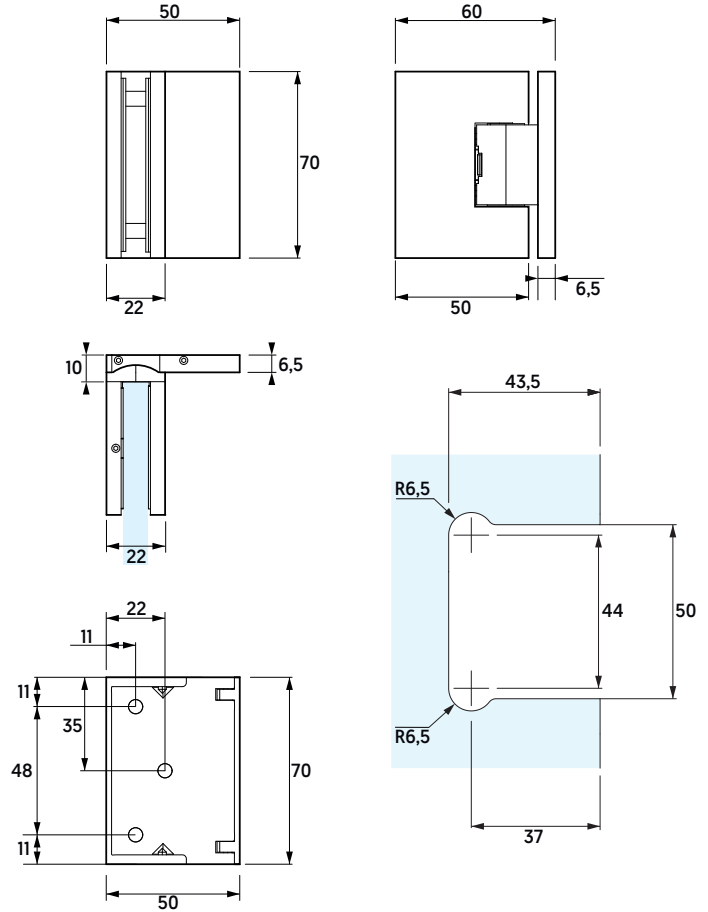

Codice	Finitura
80121103	Cromo lucido
80121109	Nero opaco

CERNIERA SFILABILE - VETRO/VETRO

Cerniera senza viti a vista
 Versione: Vetro/Vetro
 Utilizzabile per apertura a tirare o a spingere (montaggio rovescio)
Consente l'uso della guarnizione continua
 Materiale: lega AC41A ad alta resistenza

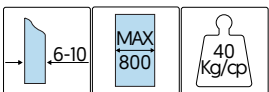
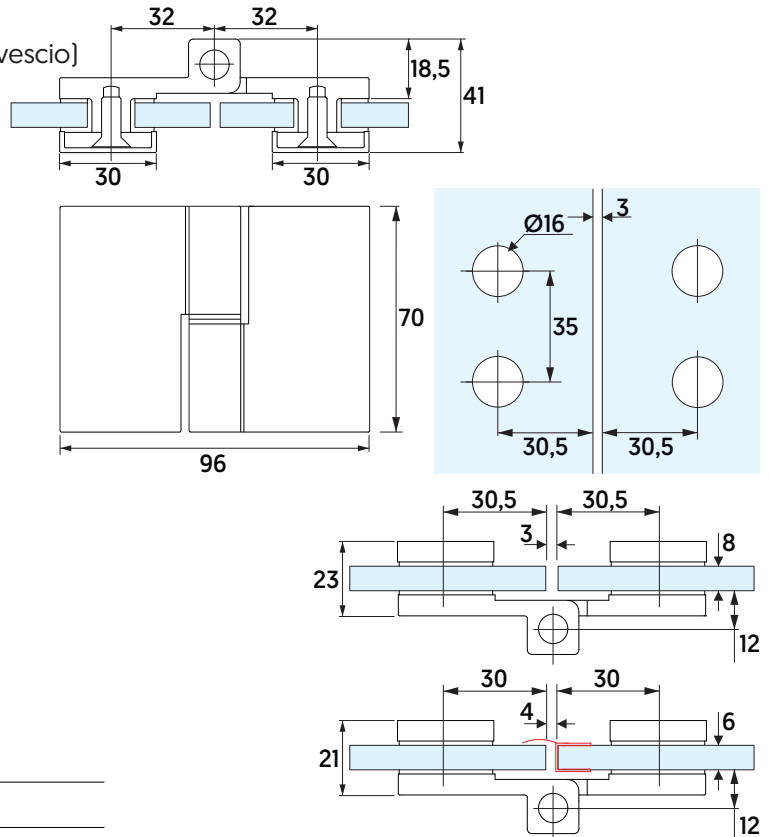

Codice	Versione	Finitura
80128761	DX	Cromo lucido
80128763	DX	Nero opaco
80128765	SX	Cromo lucido
80128767	SX	Nero opaco



GUARNIZIONE CON BATTUTA MORBIDA

Guarnizione con aletta morbida

Lunghezza profilo: 2200 mm

Materiale: pvc trasparente

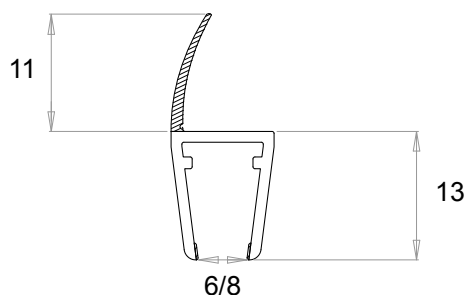
**Codice**

80124033

GUARNIZIONE A PALLONCINO

Guarnizione a palloncino

Lunghezza profilo: 2200 mm

Materiale: pvc trasparente

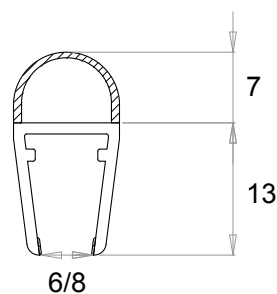
**Codice**

80124001

GUARNIZIONE A PALLONCINO ADESIVA SEMI-RIGIDA

Adesivo Tesa altamente performante in termini di tenuta, trasparenza e resistenza ad acqua ed agenti atmosferici

Lunghezza profilo: 2500 mm

Materiale: termoplastico coestruso trasparente

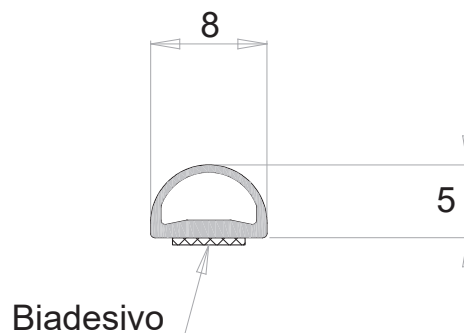
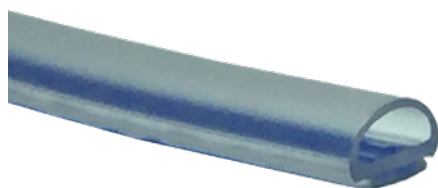
**Codice**

80124045