

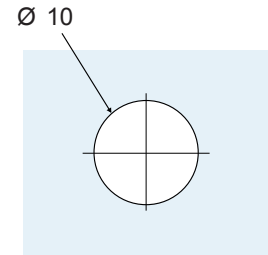

POMOLI

POMOLI A TESTA QUADRA 40X40 mm

Coppia di pomoli a testa quadra per box doccia e porte in vetro
 Meccanismo interno di centratura
 Materiale: ottone

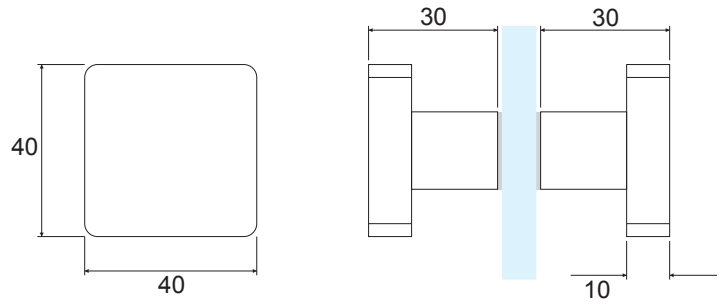
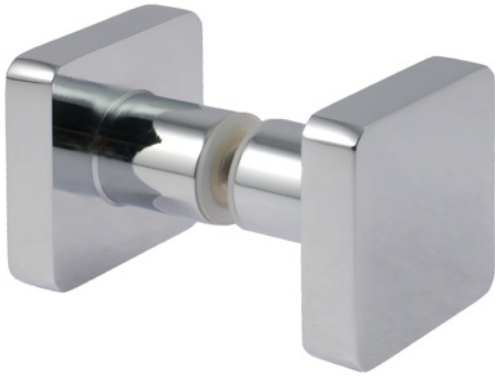

Codice	Finitura
80180096	Cromo lucido
80180098	Nichel satinato

POMOLI A SFERA Ø 50 mm

Coppia di pomoli a sfera per box doccia e porte in vetro
 Materiale: acciaio inox Aisi 304

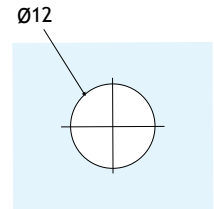
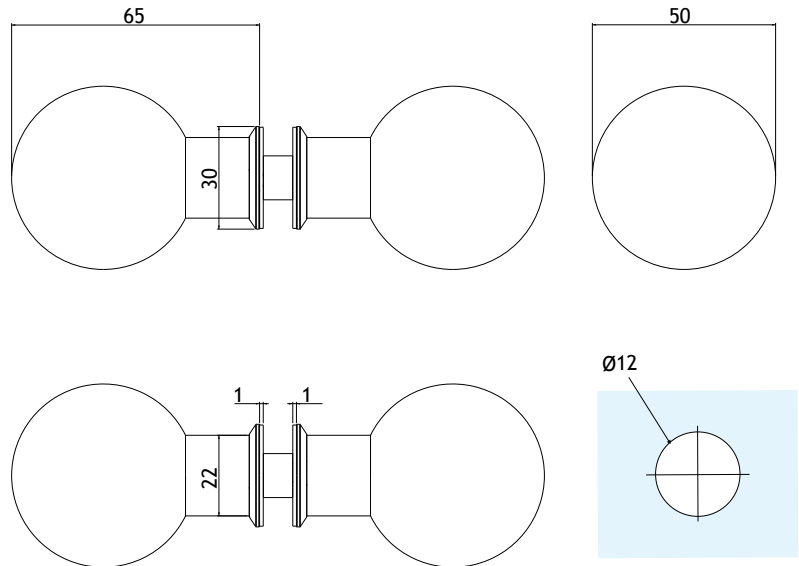

Codice	Finitura
80180076	Inox lucido
80180078	Inox satinato

POMOLI A CIPOLLA Ø 65 mm

Coppia di pomoli a cipolla
 Materiale: lega di alluminio
 *Disponibile in finitura bronzo, oro lucido, oro satinato e nero su richiesta

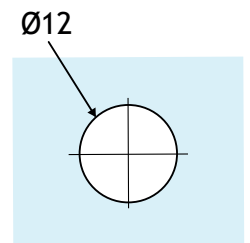
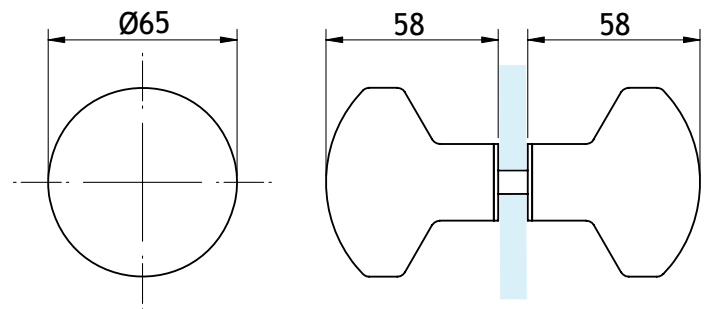

Codice	Finitura
80180087	Cromo lucido
80180085	Cromo satinato
80180089	Anodizzato naturale

POMOLI CILINDRICI Ø25 mm - CON PRESA E GRANO DI FISSAGGIO

Coppia di pomoli a cilindro con grano di fissaggio
 Con vite passante M6 x 30 mm e doppia ranella in PVC
 Materiale: ottone

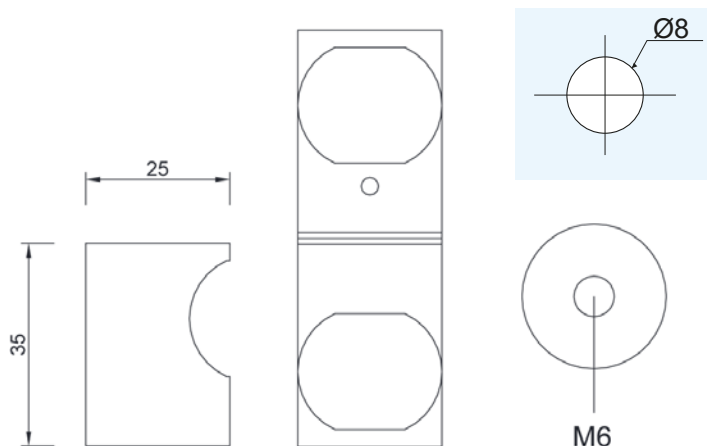

Codice	Finitura
80180070	Cromo lucido
80180072	Cromo opaco
80180073	Oro lucido
80180074	Nichel satinato

POMOLI CILINDRICI Ø30 mm - CON PRESA E TESTA BOMBATA

Coppia di pomoli cilindrici con presa
 Meccanismo interno di centratura
 Materiale: lega di zinco AC41A

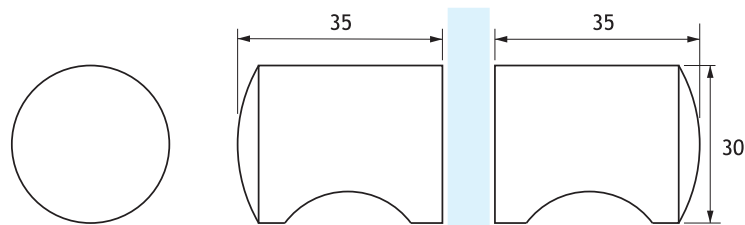

Codice	Finitura
80180390	Cromo lucido
80180392	Nichel satinato

POMOLI CILINDRICI Ø25 mm - CON PRESA E TESTA PIATTA

Coppia di pomoli cilindrici con presa
 Meccanismo interno di centratura
 Materiale: lega di zinco AC41A

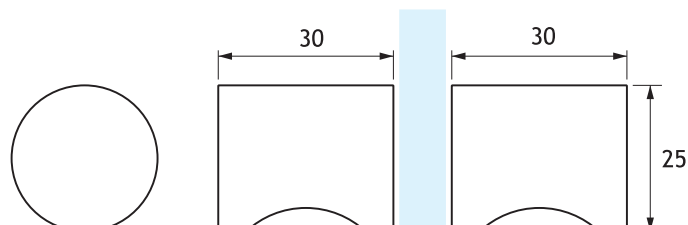

Codice	Finitura
80180394	Cromo lucido
80180395	Nero opaco
80180396	Nichel satinato
80180398	Oro lucido

POMOLI CILINDRICI Ø14 mm - CON PRESA

Coppia di pomoli a cilindro
Con vite passante M5 x 30 mm
Materiale: ottone

*Disponibile in finitura oro in su richiesta



Codice	Finitura
80180080	Cromo lucido
80180082	Cromo opaco

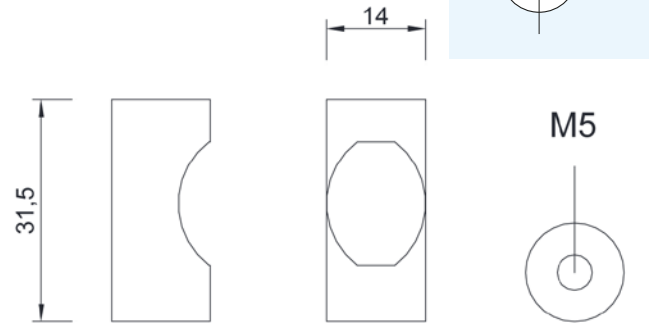

POMOLI "WIEN" CILINDRICI CON PRESA CONTINUA

Coppia di pomoli cilindrici con presa continua
Vite passante M6
Materiale: ottone



Codice	Finitura
80180320	Cromo lucido
80180323	Simil inox
80180326	Anodizzato naturale
80180329	Nero opaco

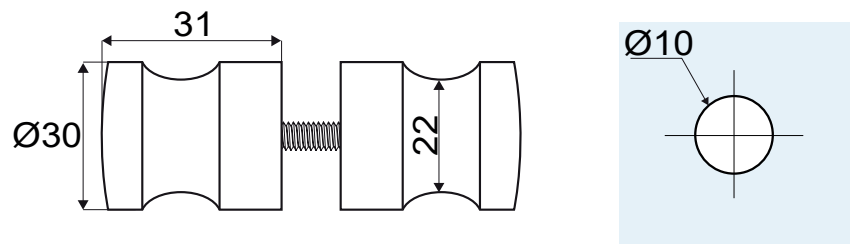

POMOLI "EUTIN" CILINDRICI CON TESTA BOMBATA

Pomoli cilindrici con testa bombata
Con grano di fissaggio
Vite passante M6
Materiale: ottone



Codice	Finitura
80180350	Cromo lucido

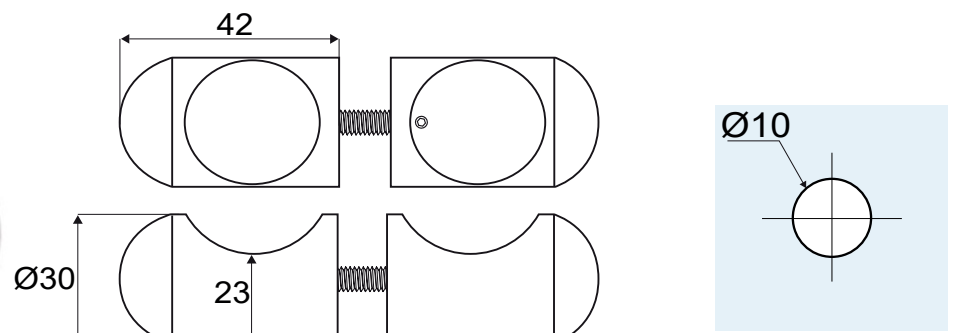

POMOLI "PORTO" CON TESTA CONICA

Coppia di pomoli con testa conica

Vite passante M6

Materiale: ottone

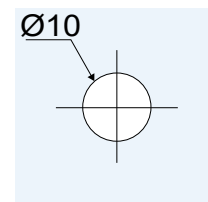
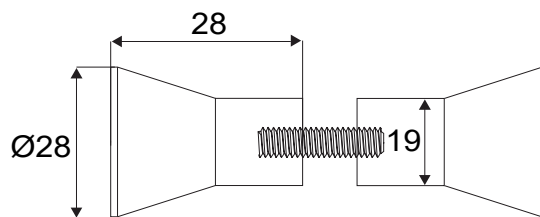

Codice

Finitura

80180310

Cromo lucido

80180313

Simil inox

80180316

Anodizzato naturale

80180319

Nero opaco

POMOLI "PARIS" A PALLA Ø35 mm

Coppia di pomoli a palla

Vite passante M8

Materiale: ottone

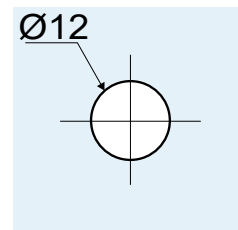
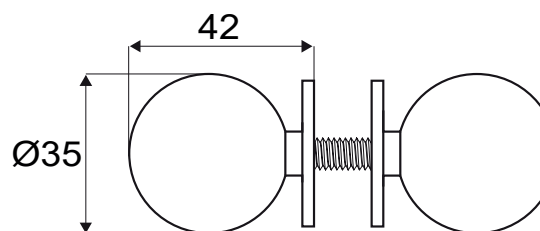

Codice

Finitura

80180330

Cromo lucido

80180333

Simil inox

80180336

Anodizzato naturale

POMOLI "KIEL" CON TESTA PIATTA

Coppia di pomoli a testa piatta

Vite passante M5

Materiale: ottone

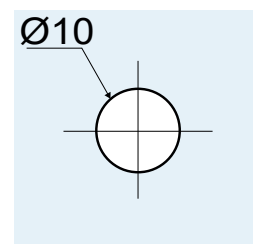
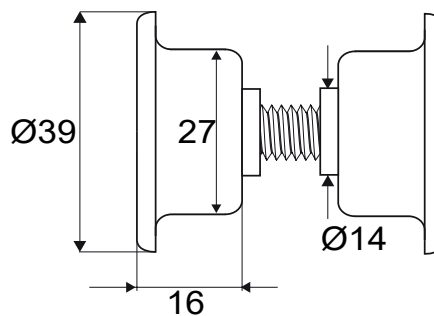

Codice

Finitura

80180340

Cromo lucido

80180349

Simil inox

80180346

Anodizzato naturale

80180343

Nero opaco

POMOLI 20X20 A SEZIONE QUADRA CON BORDI SMUSSATI

Coppia di pomoli a sezione quadra con presa
Ideale per box doccia e porte in vetro
Meccanismo interno di centratura
Materiale: ottone

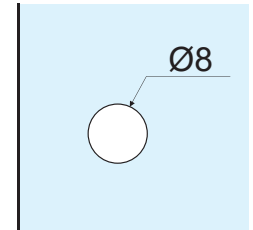
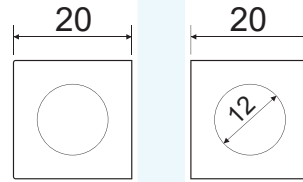
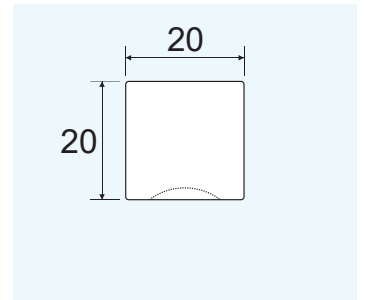
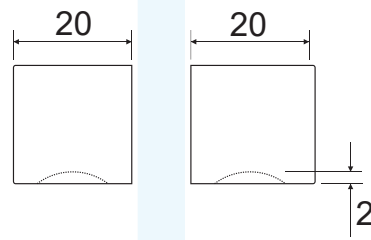

Codice	Finitura
80180104	Cromo lucido
80180106	Nichel satinato
80180108	Nero opaco

POMOLI 25X25 A SEZIONE QUADRA

Coppia di pomoli a sezione quadra
Ideale per box doccia e porte in vetro
Meccanismo interno di centratura
Materiale: lega di alluminio

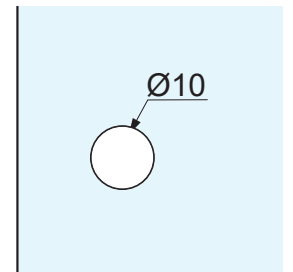
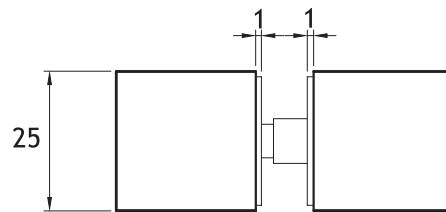
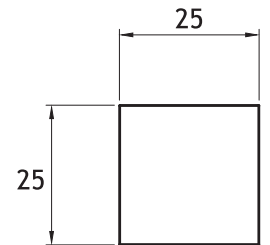
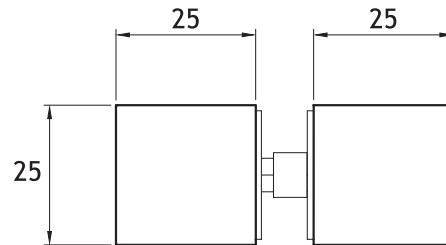
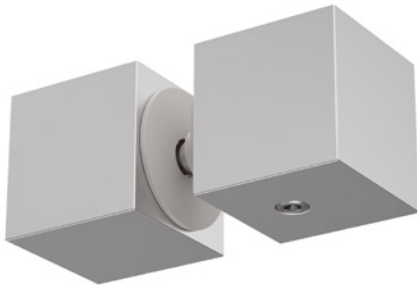

Codice	Finitura
80180414	Anodizzato lucido
80180412	Anodizzato naturale
80180416	Simil inox

POMOLI 30X30 A SEZIONE QUADRA CON PRESA

Coppia di pomoli a sezione quadra con presa
Ideale per box doccia e porte in vetro
Meccanismo interno di centratura
Materiale: lega di zinco AC41A

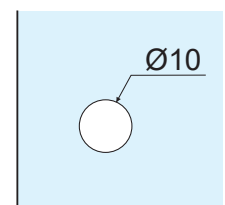
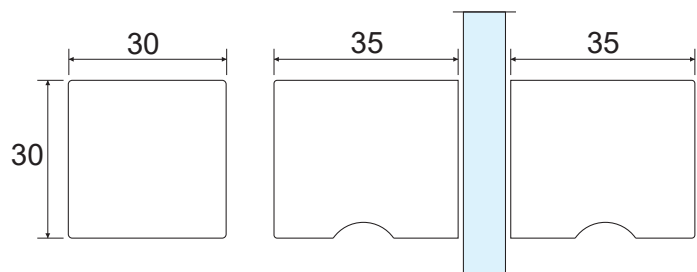

Codice	Finitura
80180100	Cromo lucido
80180102	Nichel satinato
80180101	Nero opaco

POMOLO CON TESTA SVASATA

Pomolo singolo per vetrinette

Vite passante M4 x 25 mm inclusa

Materiale: zamac

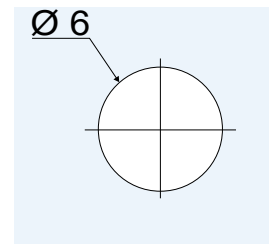
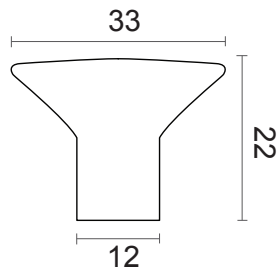

Codice	Finitura
80180360	Cromo lucido
80180363	Argento
80180366	Nichel satinato

POMOLO CON TESTA CONICA

Pomolo singolo per vetrinette

Vite passante M4 x 25 mm inclusa

Disponibile in due dimensioni

Materiale: acciaio inox

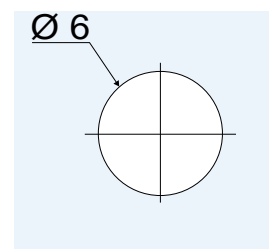
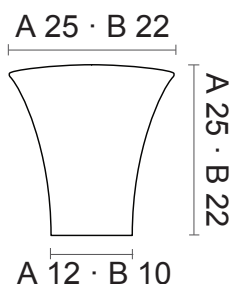

Codice	Dimensione	Finitura
80180370	A	Inox satinato
80180373	B	Inox satinato

POMOLO CILINDRICO Ø16 mm

Pomolo a cilindro

Vite passante M4 x 25 mm inclusa

Materiale: acciaio inox

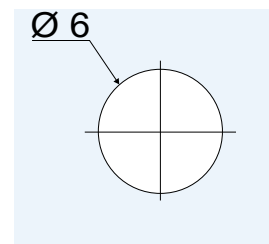
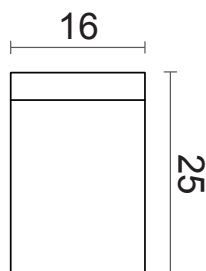

Codice	Finitura
80180380	Inox satinato

POMOLO A CLESSIDRA

Pomolo singolo per vetrinette
Vite passante M4 x 25 mm inclusa
Materiale: zamac

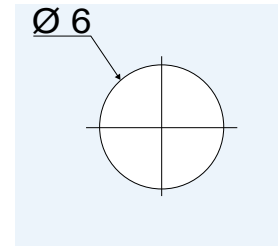
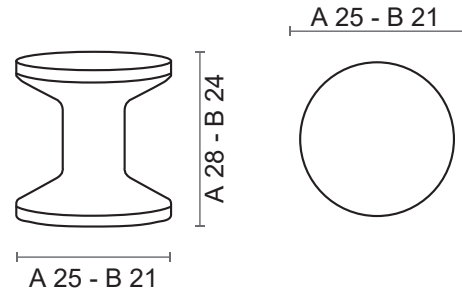

Codice	Dimensione	Finitura
80180400	A	Cromo lucido
80180402	B	Cromo lucido
80180404	A	Argento
80180406	B	Argento
80180408	A	Nichel satinato
80180410	B	Nichel satinato

POMOLO A PALLA Ø20 mm

Pomolo singolo per vetrinette
Diametro: 20 mm
Vite M4 inclusa
Materiale: ottone
***Disponibile Ø 30 mm ed altre misure su richiesta**

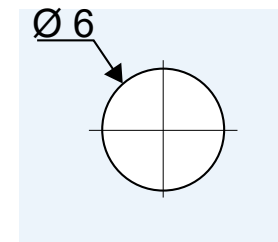
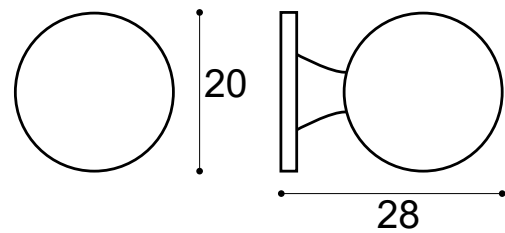

Codice	Finitura
10032001	Cromo lucido
10033001	Cromo satinato
10035001	Oro satinato
10037001	Oro lucido
10038001	Bronzo